

2013

Impairment-Aware Dynamic Routing and Wavelength Assignment in Translucent Optical WDM Networks

Sriharsha Venkata Varanasi
University of Windsor

Follow this and additional works at: <https://scholar.uwindsor.ca/etd>

Recommended Citation

Varanasi, Sriharsha Venkata, "Impairment-Aware Dynamic Routing and Wavelength Assignment in Translucent Optical WDM Networks" (2013). *Electronic Theses and Dissertations*. 4935.
<https://scholar.uwindsor.ca/etd/4935>

This online database contains the full-text of PhD dissertations and Masters' theses of University of Windsor students from 1954 forward. These documents are made available for personal study and research purposes only, in accordance with the Canadian Copyright Act and the Creative Commons license—CC BY-NC-ND (Attribution, Non-Commercial, No Derivative Works). Under this license, works must always be attributed to the copyright holder (original author), cannot be used for any commercial purposes, and may not be altered. Any other use would require the permission of the copyright holder. Students may inquire about withdrawing their dissertation and/or thesis from this database. For additional inquiries, please contact the repository administrator via email (scholarship@uwindsor.ca) or by telephone at 519-253-3000ext. 3208.

Impairment-Aware Dynamic Routing and Wavelength Assignment in
Translucent Optical WDM Networks

by

Sriharsha Venkata Varanasi

A Thesis

Submitted to the Faculty of Graduate Studies
through the School of Computer Science
in Partial Fulfillment of the Requirements for
the Degree of Master of Science at the
University of Windsor

Windsor, Ontario, Canada

2013

© 2013, Sriharsha V. Varanasi

Impairment-Aware Dynamic Routing and Wavelength Assignment in
Translucent Optical WDM Networks

by

Sriharsha Venkata Varanasi

APPROVED BY:

S. Das

Department of Civil and Environmental Engineering

J. Lu

School of Computer Science

S. Bandyopadhyay, Advisor

School of Computer Science

A. Jaekel, Advisor

School of Computer Science

September 13, 2013

DECLARATION OF CO-AUTHORSHIP/PREVIOUS PUBLICATION

I DECLARATION OF CO-AUTHORSHIP

I hereby declare that this thesis incorporates the outcome of a joint research under the supervision of professors, Dr. Subir Bandyopadhyay and Dr. Arunita Jaekel. The collaboration is covered in chapters 3 and 5 of the thesis. In all cases, the key ideas, primary contributions, experimental designs, data analysis and interpretation, were performed by me. This joint research was submitted to the International Conference on Distributed Computing and Networking 2014, as specified in the declaration below.

I am aware of the University of Windsor Senate Policy on Authorship and I certify that I have properly acknowledged the contribution of other researchers to my thesis, and have obtained written permission from each of the co-author(s) to include the above material(s) in my thesis.

I certify that, with the above qualification, this thesis, and the research to which it refers, is the product of my own work.

II DECLARATION OF PREVIOUS PUBLICATION

This thesis includes 1 original paper that has been previously submitted for publication in a peer reviewed conference, as follows:

Thesis Chapter/Section	Publication title/full citation	Publication status
1.2, 1.3, 3, 5.1, 5.2, 5.3 and 5.8	Impairment-Aware Dynamic Routing and Wavelength Assignment in Translucent Optical WDM Networks; Varanasi, S; Bandyopadhyay, S; Jaekel, A; International Conference on Distributed Computing and Networking, ICDCN 2014;	Submitted for publication

I certify that the above material describes work completed during my registration as graduate student at the University of Windsor.

I declare that, to the best of my knowledge, my thesis does not infringe upon anyones copyright nor violate any proprietary rights and that any ideas, techniques, quotations, or any other material from the work of other people included in my thesis, published or otherwise, are fully acknowledged in accordance with the standard referencing practices. Furthermore, to the extent that I have included copyrighted material that surpasses the bounds of fair dealing within the meaning of the Canada Copyright Act, I certify that I have obtained a written permission from the copyright owner(s) to include such material(s) in my thesis. I declare that this is a true copy of my thesis, including any final revisions, as approved by my thesis committee and the Graduate Studies office, and that this thesis has not been submitted for a higher degree to any other University or Institution.

ABSTRACT

Routing and wavelength assignment (RWA) is a widely discussed design problem in the optical networks literature. Physical layer impairments (PLI) degrade the quality of transmission (QOT) of a propagating optical signal inside the optical fiber and they have a significant impact on the RWA process. 3R regeneration, which is based on the expensive optical-to-electronic-to-optical (OEO) conversion technology, is a popularly used technique to restore the degraded QOT of an optical signal. In order to minimize both capital and operational costs, it is highly desirable to use a translucent optical network, in which the 3R regenerators are sparsely yet strategically placed. This thesis presents a novel impairment-aware RWA approach, called best first search RWA (BFS-RWA), for dynamic connection requests, in a translucent optical network. BFS-RWA is based on the A* best first search algorithm and guarantees an optimal solution (i.e. using the least possible number of regenerators).

DEDICATION

To my loving parents:

Father: Padmanabham Varanasi

Mother: Kameswari Varanasi

ACKNOWLEDGEMENTS

I would like to take this opportunity to convey my sincere thanks to my supervisors, Dr. Subir Bandyopadhyay and Dr. Arunita Jaekel, for their constant guidance and support all throughout my graduate studies. This work could not have been achieved without their continuous encouragement, advice, suggestions and cooperation.

I would like to thank members of my M.Sc. thesis committee, Dr. Sreekanta Das, Dr. Jianguo Lu and Dr. Asish Mukhopadhyay for their valuable time, suggestions and constructive comments.

Finally, I would like to thank Dr. Quazi R. Rahman, for providing his regenerator placement software and helping me in understanding its working.

Sriharsha V. Varanasi

TABLE OF CONTENTS

DECLARATION OF CO-AUTHORSHIP/ PREVIOUS PUBLICATION	iii
ABSTRACT	v
DEDICATION	vi
ACKNOWLEDGEMENTS	vii
LIST OF TABLES	xi
LIST OF FIGURES	xii
LIST OF ACRONYMS	xiv
1 INTRODUCTION	1
1.1 Overview	1
1.2 Motivation	2
1.3 Problem Statement	5
1.4 Organization of Thesis	7
2 REVIEW	8
2.1 Fundamentals of Fiber-Optic Communication	8
2.1.1 Optical Fiber	8
2.1.2 Optical Network Components	10
2.2 Routing and Wavelength Assignment (RWA)	11
2.3 Physical Layer Impairments (PLI)	12
2.3.1 Linear Impairments	12

2.3.2	Non-Linear Impairments	13
2.4	An OSNR based Model to Estimate PLI	15
2.4.1	Structure of a Link in the Network	16
2.4.2	Gains and Losses in the Optical Fiber	16
2.4.3	Estimating Impairments	17
2.4.4	Computing OSNR (dB) Values	19
2.5	3R Regeneration	20
2.6	Types of Optical Networks	21
2.7	Designing Translucent Networks	22
2.7.1	Regenerator Placement Problem (RPP)	22
2.7.2	Routing with Regenerators Problem (RRP)	23
2.8	Related Works on RRP	23
3	BEST FIRST SEARCH RWA (BFS-RWA)	26
3.1	Notation used in BFS-RWA	27
3.2	Details of BFS-RWA	29
3.2.1	Actual and Heuristic Costs	29
3.2.2	Main Algorithm	30
3.2.3	Lightpath Feasibility, Channel Assignment and Existence of Loops	32
3.3	Example	34
4	TEST BENCH FOR SIMULATION	38
4.1	Simulator Overview	38
4.2	Network Topology Generator	41
4.3	Shortest Distance Generator	42
4.4	Dynamic Connection Requests	43
4.5	RPP Module	45

4.6	OSNR Tool	46
4.7	RRP Module	48
5	RESULTS	50
5.1	Blocking Probability vs Traffic Load	51
5.2	RPP using Different Values of Optical Reach	52
5.3	Effect of Varying the Number of Regenerators	53
5.4	Importance of RPP Approach	55
5.5	Effect of a Distributed Regenerator Placement	57
5.6	Opaque vs Translucent Optical Network	58
5.7	Effect of Non-Linear Impairments	59
5.8	Execution Time of BFS-RWA	60
6	CONCLUSIONS & FUTURE WORK	61
6.1	Conclusions	61
6.2	Future Work	62
	REFERENCES	64
	VITA AUCTORIS	68

LIST OF TABLES

3.1	List of existing lightpaths	35
3.2	Transparent segments of a lightpath with loops	37
4.1	Summary of simulator components	39
4.2	Network topology matrix	42
4.3	Network configuration parameters	42
4.4	Shortest distance matrix	42
4.5	Connection setup and teardown events sequence	44
4.6	List of existing lightpaths	46
4.7	Route matrix: Input to OSNR tool	47
4.8	Wavelengths assigned for the route matrix in Table 4.7	47
5.1	Table showing distribution of regenerators	58

LIST OF FIGURES

1.1	A translucent optical network	4
1.2	Occurrence of loops in lightpaths	6
2.1	Cross section of an optical fiber	8
2.2	(a) Total internal reflection inside optical fiber (b) Reflection and transmission of a light ray	9
2.3	Structure of an optical node showing different components	10
2.4	Adjacent channel interference	14
2.5	Intrachannel crosstalk	15
2.6	Structure of a link in the network	16
2.7	3R Regeneration	20
2.8	Types of Optical Networks (a) Transparent (b) Translucent (c) Opaque	21
3.1	A 6 node translucent optical network	35
3.2	Search tree after generating (a) node labelled A (b) node labelled G .	35
3.3	(a) A sample translucent network (b) Path Intersection Graph (PIG)	37
4.1	BFS-RWA Simulator block diagram	38
4.2	A sample network topology with 6 nodes	42
4.3	A sample network topology with 6 nodes	42
4.4	RPP solution based on optical reach for a random network topology	45
4.5	Sample network topology	46
5.1	Average Blocking Probability vs Traffic Load for 16 channels	51
5.2	Average Blocking Probability vs Traffic Load for 32 channels	51
5.3	Regenerator Placement using different values of optical reach (r)	52
5.4	Effect of varying the number of regenerators for 50 Erlangs	53
5.5	Effect of varying the number of regenerators for 10 Erlangs	54
5.6	RPP random vs RPP using optical reach = 300km	55
5.7	RPP random vs RPP using optical reach = 200km	55

5.8	Effect of distributing the available regenerators in the network	57
5.9	Blocking probability: Opaque vs Translucent optical network	58
5.10	Effect of non-linear impairments on blocking probability	59
5.11	Average execution time of 1 simulation(in secs)	60

LIST OF ACRONYMS

ASE	Amplified Spontaneous Emission
BFS-RWA	Best First Search for Route and Wavelength Assignment
CD	Chromatic Dispersion
DLA	Dynamic Lightpath Allocation
FTTH	Fiber to the Home
FWM	Four Wave Mixing
IA-RWA	Impairment-Aware RWA
ILP	Integer Linear Programming
OSNR	Optical Signal to Noise Ratio
PLI	Physical Layer Impairments
PMD	Polarization Mode Dispersion
QOT	Quality of Transmission
RPP	Regenerator Placement Problem
RRP	Routing with Regenerators Problem
RWA	Routing and Wavelength Assignment
WDM	Wavelength Division Multiplexing
WWW	World Wide Web
XPM	Cross-Phase Modulation
XT	Switch Crosstalk

1 INTRODUCTION

1.1 Overview

The World Wide Web (WWW) or Internet as it is called popularly, is growing at a very fast rate, driven by large amounts of online information, electronic commerce, entertainment, cloud computing and social networking. At the same time, the number of internet users has also doubled in the past decade (with 39% of the world population using the internet in 2013 [1]). In addition, the global telecommunications industry has seen an exponential growth in the last decade. All these developments have created a great demand for reliable communications with very high data transfer rates (commonly referred to as the *bandwidth*).

To facilitate communication there exist a wide range of media, copper cable being the traditionally preferred medium of data transmission. The copper cable based networks pose several constraints including lack of high bandwidth capacity, sensitivity to environmental noise and high signal attenuation. The optical fiber technology has emerged as a promising solution to the problems hindering the traditional communication using copper cables. Optical fibers are thin glass cylinders which carry data in the form of light or optical signals. Optical fibers address all the major constraints posed by the copper cables and offer significantly higher bandwidth capacities of the order of Terabits per second (Tbps). An optical network is essentially an interconnection of computers and other devices (that can store data in an electronic form) using optical fibers. It also includes other components to generate the optical signals from electronic data and to route the optical signals through the network (A detailed discussion on various optical network components is presented in section 2.1). Optical networks span across cities, countries & continents and act as a backbone to support other major forms of communication such as wireless. With recent advancements in optical fiber technology, the general perception of optical networks as backbone

networks is changing and they are also being increasingly used in providing last mile communication directly to the end users. This is popularly known as Fiber to the Home (FTTH) technology [2], where the end user is directly connected to the optical fiber. Google Fiber [3] is one such recent example of the FTTH technology.

The huge success of optical fiber communication is mainly attributed to the *Wavelength Division Multiplexing* (WDM) [4] technology. The entire bandwidth available for transmission in an optical fiber can be visualized as a set of channels (or wavelengths¹) [4], with each channel being assigned to an optical signal. The channels are separated by a minimum spacing (called *channel spacing*) to prevent interference between signals travelling on adjacent channels. The WDM technology enables multiple optical signals, using different channels, to be transmitted simultaneously over a single optical fiber, with each signal having a data rate of the order of gigabits per sec (Gbps).

1.2 Motivation

Optical level connections, called lightpaths [4], are used to route the optical signals in the network. A lightpath is characterized by a route (spanning multiple optical fibers) and a channel(s) along the route. In essence, each connection request is served by a lightpath. The process of establishing lightpaths is called *Routing and Wavelength Assignment* (RWA) [4], which belongs to the NP-Complete [5] class of problems in computer science.

The idea behind optical communication is to convert data in electronic form into an optical signal, transmit the signal along the optical fibers in the network and retrieve the data back to electronic form at the destination. In order to ensure that the optical signal is decoded back correctly to electronic form at the destination, the signal is required to have a certain acceptable level of strength or quality called as

¹The terms *channel* and *wavelength* are used interchangeably in the remainder of the thesis.

the Quality of Transmission (QOT). As the signal propagates through the optical fiber, its QOT is degraded due to several physical phenomena termed as Physical Layer Impairments (PLI) [6]. Some of the important PLI² include Optical Noise, Amplified Spontaneous Emission (ASE), Chromatic Dispersion (CD), Polarization Mode Dispersion (PMD) [7], Cross-Phase Modulation (XPM), Switch Crosstalk (XT) and Four Wave Mixing (FWM) [8]. PLI can be classified into two categories [6] namely i) *Linear* impairments and ii) *Non-linear impairments*. Linear impairments affect a lightpath individually and are not dependant on the existence of other lightpaths in the network. Non-linear impairments are generated mainly due to the interference between lightpaths. RWA which takes into account the PLI is called *Impairment-Aware RWA* (IA-RWA). The addition of PLI to RWA makes the problem even more intractable.

The optical signal needs to undergo regeneration before its QOT falls below a pre-determined threshold value. Optical regenerators are still in the research stage and are very expensive for commercial deployment. As a result the regeneration is carried out in the electronic domain which is termed as 3R regeneration (Reamplification, Reshaping and Retiming) [9]. 3R regenerators typically use Optical-to-Electronic-to-Optical (OEO) conversion [9], to first convert the optical signal to electronic form, perform regeneration and then finally convert the electronic data back to an optical signal. OEO conversion is an expensive operation and also presents a bottleneck in terms of speed because electronic devices work slower than the optical ones. This forces the 3R regenerators to be used sparingly in the network. The maximum distance an optical signal can travel before it needs 3R regeneration is called the *optical reach* [10]. Optical reach is a widely used metric that is calculated based on linear impairments. However it does not consider non-linear impairments because they cannot be estimated before the lightpath is actually established.

²A detailed review of PLI is presented in section 2.3

In an *opaque* optical network, all the nodes are capable of providing 3R regeneration. The deployment of regenerators in the network nodes incurs Capital Expenditure (CAPEX) [11]. Also, several other practical considerations such as power consumption, heat dissipation, physical space required [11] etc., which contribute to the operational expenditure (OPEX) [11], have to be looked at once the network is in operation. In order to minimize both CAPEX and OPEX costs network designers are moving towards a low cost solution in the form of *translucent* optical networks, in which only few of the network nodes are capable of providing 3R regeneration.

In order to solve problems related to optical network planning and operation, the physical network topology is represented in the form of a graph with the vertices representing the network nodes and the edges representing the optical fibers between them. A lightpath which does not involve (involves) 3R regeneration is called a *transparent (translucent)* lightpath. A translucent lightpath may be viewed as having two or more components, where each component is a transparent lightpath. Such a transparent component is usually called a *segment* of the translucent lightpath. The end nodes of a segment can be any of the following namely i) the source node and a regenerator node or ii) two regenerator nodes or iii) a regenerator node and the destination node. Fig. 1.1 shows a translucent network, where nodes 0 and 1 are capable of 3R-regeneration. A translucent lightpath having route $3 \rightarrow 2 \rightarrow 1 \rightarrow 0 \rightarrow 4 \rightarrow 5$, with regeneration at nodes 1 and 0, consists of 3 transparent segments, having routes $3 \rightarrow 2 \rightarrow 1$, $1 \rightarrow 0$ and $0 \rightarrow 4 \rightarrow 5$.

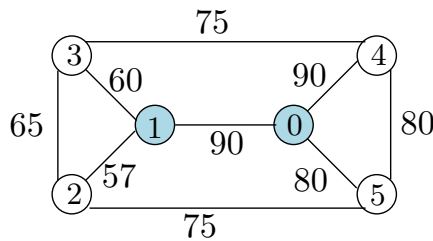

Fig. 1.1: A translucent optical network

Dynamic Lightpath Allocation (DLA) [6] is considered in this thesis. In DLA, connection requests (each specified by a source s , a destination d and a duration of communication) arrive dynamically and the pattern of arrival of these requests cannot be predicted. As a result, it is not possible to determine, in advance, which nodes may need 3R regeneration capability. In translucent networks where DLA is used, there are two phases: i) the *Regenerator Placement Problem (RPP)* phase [12], which is carried out before the network starts operating and ii) the *Routing with Regenerators Problem (RRP)* [12] phase, which is carried out only when the network is in operation. Given a WDM network topology, the objective of RPP is to identify the smallest possible subset of nodes (\mathbb{N}), which will have 3R regeneration capability, to ensure full connectivity. In other words, corresponding to every (source, destination) pair (s, d) , a route for a translucent lightpath from s to d exists, such that the length of each of the segments of the lightpath is less than the optical reach. The objective of RRP is to setup, if possible, a transparent or a translucent lightpath for a connection request from s to d . The attempt may fail due to i) network layer limitations (no available channel), ii) physical layer impairments, or iii) lack of regenerators. To conserve resources, algorithms for RRP attempt to minimize the number of regenerators used in the translucent lightpath from s to d .

1.3 Problem Statement

In this thesis, the focus is on the RRP phase and a novel IA-RWA approach for DLA, called *Best First Search for Route and Wavelength Assignment (BFS-RWA)*, is proposed. The interesting features of BFS-RWA are as follows:

- The BFS-RWA approach is based on the A^* algorithm [13] and uses an admissible heuristic [13]. Thus, an optimal solution, if it exists, is guaranteed. Existing RRP approaches proposed in [12], [14], [15], [16], [17] & [18] use a set of k pre-computed candidate paths (from the source to the destination of the connection

request) to select a feasible route for the lightpath. Using a candidate set of paths leads to an incomplete exploration of the solution space and may fail to find a feasible route. Also, none of the existing approaches guarantee an optimal solution for the connection request. The BFS-RWA performs an exhaustive search for to find the solution and leaves no possibility unexplored. Therefore BFS-RWA is ideally suited to serve as a benchmark for any algorithm for RRP.

- Unlike transparent lightpaths, a translucent lightpath may have loops (i.e. the same edge can appear multiple times in a translucent lightpath). A sample translucent optical network is shown in Fig. 1.2, where only node 4 is capable of 3R-regeneration.

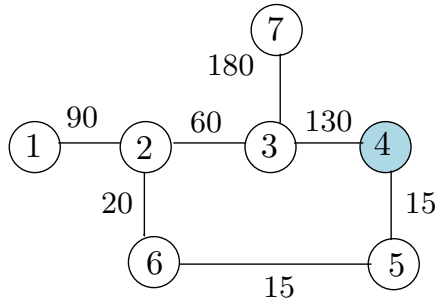

Fig. 1.2: Occurrence of loops in lightpaths

Assuming an optical reach of 300 km, an optical signal starting at node 1 cannot reach node 7 without undergoing regeneration at node 4. The only possible translucent lightpath from 1 to 7 has the route $1 \rightarrow 2 \rightarrow 3 \rightarrow 4 \rightarrow 5 \rightarrow 6 \rightarrow 2 \rightarrow 3 \rightarrow 7$. In this case, the edge $2 \rightarrow 3$ is shared by the transparent segments using routes $1 \rightarrow 2 \rightarrow 3 \rightarrow 4$ and $4 \rightarrow 5 \rightarrow 6 \rightarrow 2 \rightarrow 3 \rightarrow 7$. As a result these segments cannot be assigned the same channel. This property was pointed out for the first time in [12]. None of the other existing approaches on RRP handle this property. Also, the authors in [12] only consider optical reach (i.e. linear impairments only). BFS-RWA is the first approach to handle loops in lightpaths

considering both linear and non-linear PLI.

- Optical reach is a distance-based metric and only accounts for linear impairments. As mentioned before, non-linear impairments are not considered in the optical reach because they cannot be quantified until the lightpaths are actually established. One possibility is to assume the worst case for non-linear impairments during the RPP phase, following [15]. However, this increases the number of regenerators and hence the expenses involved. The BFS-RWA allows us to study the impact of different regenerator placement strategies on the lightpath blocking probability [12].

1.4 Organization of Thesis

Chapter 2 contains a detailed review of the fundamental concepts of fiber optic communication and other related topics on optical networks. A review of the previous works on RRP, is also presented in Chapter 2. The proposed BFS-RWA approach is presented in Chapter 3. Chapter 4 describes the test bench used to run the simulations. Chapter 5 presents the simulation results and related analysis. Finally the conclusions and possible future work are presented in Chapter 6.

2 REVIEW

2.1 Fundamentals of Fiber-Optic Communication

2.1.1 Optical Fiber

An optical fiber is a very thin cylinder made up of high quality extruded glass (silica) and it is slightly thicker than the human hair. A typical optical fiber is made 3 layers namely core, cladding and the coating (or buffer). Both the core and cladding are made up of glass whereas the buffer is made up of plastics such as acrylic or nylon. The buffer prevents physical damage to the fiber and also provides the bending flexibility. The optical cable used for communication uses several layers of buffer around the fiber. Fig. 2.1 shows the cross section of a typical optical fiber (with the respective thicknesses of each layer).

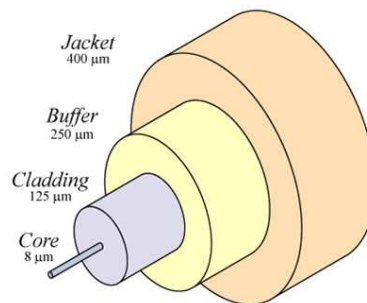

Fig. 2.1: Cross section of an optical fiber

The optical signal is transmitted in the core of the optical fiber and the principle of *total internal reflection* [4] is used to confine the optical signal to the core without leaking out of it. When light travels from a denser medium (i.e. with a higher refractive index) to a rarer medium (i.e with a lower refractive index), the light ray undergoes complete reflection into the denser medium, if it is incident at an angle greater than the critical angle of incidence (θ_c) for the boundary. This is called *total internal reflection* [4].

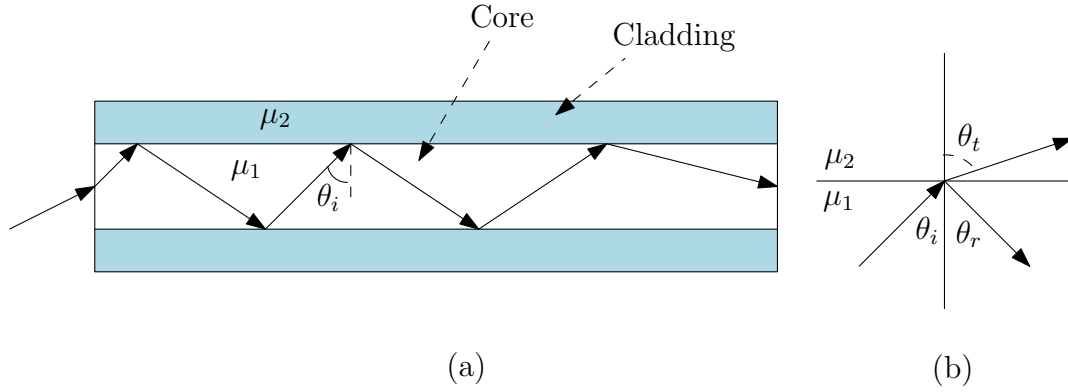

Fig. 2.2: (a) Total internal reflection inside optical fiber (b) Reflection and transmission of a light ray

Fig. 2.2(a) shows the working of total internal reflection inside an optical fiber. When a ray of light is incident at the boundary of two media having different refractive indices, a part of the light ray is reflected back into the same medium and a portion of it is transmitted into the other medium, as shown in Fig. 2.2(b). The angles of incidence, reflection and transmission (or refraction) being θ_i , θ_r and θ_t respectively. μ_1 and μ_2 are the refractive indices of the two media. According to Snell's law in optics:

$$\mu_1 * \sin \theta_i = \mu_2 * \sin \theta_t \quad (1)$$

It can be observed from eqn. 1 that as θ_i increases, θ_t also increases. When θ_i is increased sufficiently so that $\theta_t = 90$ degrees, there will be no ray transmitted into the other medium (μ_2). Since $\sin 90 = 1$, eqn. 1 can be rearranged as:

$$\theta_c = \theta_i = \sin^{-1} \left(\frac{\mu_2}{\mu_1} \right) \quad (2)$$

For an angle of incidence greater than θ_c (i.e critical angle of incidence), the light ray will be completely reflected back into the same medium. This way the optical signal propagates in the fiber by having multiple total internal reflections in the core.

2.1.2 Optical Network Components

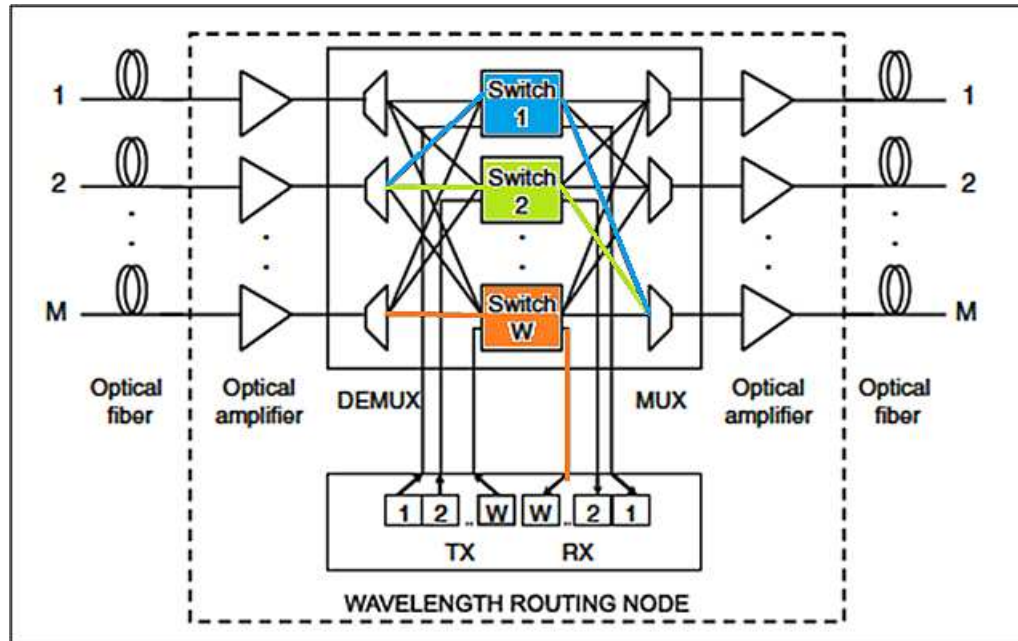

Fig. 2.3: Structure of an optical node showing different components

Fig. 2.3 shows the typical structure of a node in an optical network [19]. The node in Fig. 2.3, has a total of M incoming and outgoing optical fibers. The node is composed of the following main components:

- **Transmitter (TX) and Receiver (RX):** The transmitter (TX) is used to generate light or optical signal of a particular carrier wavelength. Modulation technique is used to convert data in electronic form to encode the optical signal [4]. *On-off keying* (OOK) [4] is a popularly used modulation technique, which encodes a bit 0 (1) by turning light off (on). The receiver (RX) is used to extract the data from the encoded optical signal back into the electronic form at the destination node. Each channel has a corresponding (transmitter, receiver) pair as shown in Fig. 2.3.
- **Demultiplexer (DEMUX) and Multiplexer (MUX):** A MUX is used to combine optical signals on different channels, onto a single optical fiber. The

DEMUX performs the opposite operation of dividing the optical signals propagating on a single optical fiber onto their respective channels. Each optical fiber has a pair of MUX and DEMUX, which enable wavelength division multiplexing (WDM) to be performed for optical transmission.

- **Optical Cross-Connect Switch (OXC):** The function of the OXC is to route the incoming optical signals to the respective outgoing fiber. If the node happens to be the destination for the signal, then the OXC routes the incoming optical signal to the respective receiver (RX) module. Similarly the transmitter (TX) sends a new optical signal, generated at this node, to the respective switch for further routing. The cross-connect switches can be classified as *static* or *dynamic* [4], depending on whether the connections between the outputs of the DEMUX and the inputs of the MUX are fixed or configurable. In Fig. 2.3 the node contains an OXC fabric, with a dedicated switch for every channel. As an example, Switch 1 handles all incoming optical signals using channel 1.
- **Optical Amplifier:** Optical amplifier is a device that boosts the strength of a propagating optical signal without having to convert it to the electronic form. Optical amplifiers are placed at a periodical distance of 80 km along the fiber.

2.2 Routing and Wavelength Assignment (RWA)

Routing and wavelength assignment (RWA) [4] is the problem of assigning to each lightpath, a route through the physical topology and a channel number (or wavelength). While performing RWA, two important constraints need to be considered namely:

1. **Wavelength Clash Constraint:** Any two lightpaths which share a common optical fiber, should be assigned different channel numbers (or wavelengths).

2. **Wavelength Continuity Constraint** [4]: The channel number assigned to a lightpath should be the same for all the optical fibers in its route. This channel number may change if a 3R regenerator (or wavelength converter)³ is used in the route.

RWA is performed on two types of traffic demands, namely *static* and *dynamic*. Static demands are known a priori to the network operator at the time of performing the RWA. Dynamic traffic demands are not known in advance and are established as they arrive in the system. The general objective of RWA, whether static or dynamic, is to maximize the number of established lightpath requests.

Static RWA is a well known NP-complete problem [5]. The dynamic RWA is even more difficult because of the fact that, the dynamic connection requests arrive randomly and remain in the network for random amounts of time [20].

Integer linear programming (ILP) [4] is a popularly used technique to find an optimal solution for the RWA problem for small networks. The ILP approach becomes computationally intractable, as the size of the network increases [4]. Therefore, heuristic approaches are generally used to solve the RWA problem for medium and large sized networks [4].

2.3 Physical Layer Impairments (PLI)

Physical layer impairments (PLI) can be classified into two categories [6] namely i) *Linear* impairments and ii) *Non-linear impairments*. Some of the important linear and non-linear impairments are discussed in the subsequent sections.

2.3.1 Linear Impairments

Linear impairments affect a lightpath individually and are not dependant on the existence of other lightpaths in the network. Some of the important linear impairments

³Explained in Section 2.5

are discussed below.

- **Amplified Spontaneous Emission (ASE):** Amplified Spontaneous Emission (ASE) is the light produced when spontaneous emission is amplified by the optical amplifiers in the fibers. The optical amplifier treats spontaneous emission as a separate signal at a certain frequency and amplifies it in addition to the actual optical signal that is incident on it. This ASE appears as noise at the output of the amplifier [7].
- **Chromatic Dispersion (CD):** Chromatic Dispersion is a phenomenon due to which the different components or frequencies of an optical signal travel with different velocities in the optical fiber. As a result they arrive at the end of the fiber at different times [7]. This impairment accumulates as the fiber length increases. Dispersion Compensating Fibers (DCF) are widely used to counter the effects of Chromatic Dispersion. DCF provide negative chromatic dispersion [7] and the accumulated CD is compensated in the optical fibers.
- **Polarization-Mode Dispersion (PMD):** Polarization-Mode Dispersion is an optical phenomenon caused due to the non-circular nature of the optical fiber core. As a result, the different polarizations of an optical signal travel with different velocities and arrive at the destination nodes at different times [7].

2.3.2 Non-Linear Impairments

Non-linear impairments are generated mainly due to the interference between lightpaths. They affect some or all of the established lightpaths in the network. Some of the important non-linear impairments are discussed below.

- **Cross Phase Modulation (XPM):** Cross phase modulation (XPM) or adjacent channel interference is caused due to the presence of lightpaths on adjacent channels of an optical fiber link. An example of adjacent channel interference

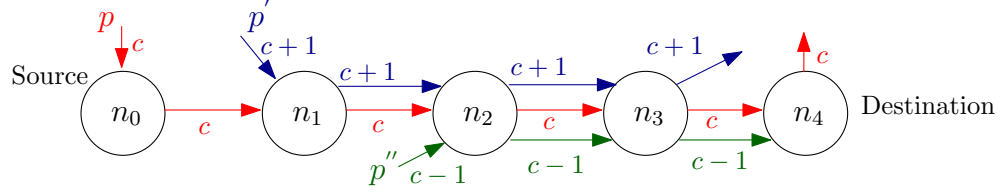

Fig. 2.4: Adjacent channel interference

effect is shown in Fig. 2.4. In Fig. 2.4 three lightpaths namely p , p' and p'' are considered. Lightpath p spans from node n_0 to n_4 and is assigned the channel c . Channels $c - 1$ and $c + 1$ are adjacent to c . Lightpath p' carries the channel $c + 1$ and shares links (n_1, n_2) and (n_2, n_3) with lightpath p . Similarly, lightpath p'' carries the channel $c - 1$ and shares links (n_2, n_3) and (n_3, n_4) with lightpath p . Hence, lightpath p experiences adjacent channel interference effect on links (n_1, n_2) , (n_2, n_3) and (n_3, n_4) due to first adjacent channels. Second adjacent channels (namely $c - 2$ and $c + 2$) also add to the overall XPM value, but their contribution is very small compared to first adjacent channels.

- **Four Wave Mixing (FWM):** Four Wave Mixing is an optical phenomenon in which three channels (or the respective frequencies) interact and generate a fourth channel. Four Wave Mixing acts as an impairment when the fourth channel happens to coincide with one of the actual channels in the optical fiber. As an example consider three channels namely λ_0 , λ_1 and λ_2 . Let $\Delta\lambda$ represent the channel spacing in the optical fiber such that:

$$\lambda_1 = \lambda_0 + \Delta\lambda$$

$$\lambda_2 = \lambda_0 + 2*\Delta\lambda$$

A particular combination of the three channels could be $\lambda_1 + \lambda_2 - \lambda_0 = \lambda_0 + 3*\Delta\lambda$, which happens to be channel λ_3 of the fiber. In this case, the mixing of the three channels will have a deteriorating effect on the lightpath established on channel λ_3 . Hence, in FWM the critical channel combinations are those that

happen to coincide with the channels of the given optical fiber.

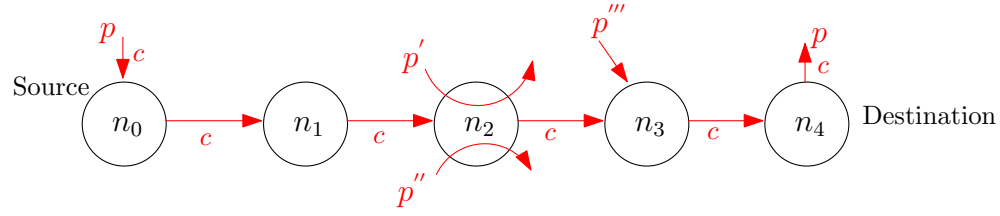

Fig. 2.5: Intrachannel crosstalk

- Optical Switch Cross Talk (XT):** Optical switch cross talk or intrachannel crosstalk is a non-linear impairment that occurs due to the leakage of power between lightpaths [21] crossing the same node (optical switch) and carrying the same channel. The authors in [21] state that intra channel crosstalk cannot be filtered, because the interfering signals carry the same channel. An example of XT is shown in Fig. 2.5. Four lightpaths namely p , p' , p'' and p''' are considered in this example, that carry the same channel c . The effect of XT can be seen at node n_2 where lightpaths p , p' and p'' cross. The effect of XT can also be observed at node n_3 where lightpaths p and p''' cross.

2.4 An OSNR based Model to Estimate PLI

[19] presents an analytical model to estimate the physical layer impairments in optical WDM networks. This model is fundamentally based on the concept of *Optical signal to noise ratio* (OSNR), which can be defined as the ratio of the total optical signal power to the total noise power at any given node in the network. This model takes into account both linear and non-linear physical layer impairments.

Amplified Spontaneous Emission(ASE) is the principal linear impairment considered in this model. Chromatic Dispersion is assumed to be totally compensated in the network links. Optical Switch Cross Talk and FWM are the non-linear impairments considered in this model. The following sections summarize the OSNR model proposed in detail.

2.4.1 Structure of a Link in the Network

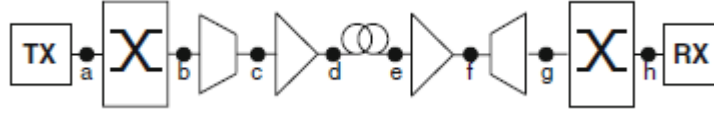

Fig. 2.6: Structure of a link in the network

The authors in [19] assume the configuration an optical fiber, connecting any two nodes in the network, to be as shown in Fig. 2.6. The network components shown in Fig. 2.6 are described below:

1. Between a and b \rightarrow Optical cross-connect switch
2. Between b and c \rightarrow Multiplexer
3. Between c and d \rightarrow Optical amplifier
4. Between d and e \rightarrow Fiber itself
5. Between e and f \rightarrow Optical amplifier
6. Between f and g \rightarrow Demultiplexer
7. Between g and h \rightarrow Optical cross-connect switch

2.4.2 Gains and Losses in the Optical Fiber

Corresponding to every network component identified above, the authors in [19] associate a gain or a loss term. The Loss terms are associated with the multiplexer, demultiplexer and the optical cross-connect switch components, which are represented as L_{Mux} , L_{Demux} and L_{Switch} respectively. The two optical amplifiers in the fiber, have gain terms represented by G_{amp1} and G_{amp2} respectively. The amplifiers also have noise figures associated with them represented by F_{amp1} and F_{amp2} respectively. The amplifier gain and noise figures depend on the optical signal power values at

their input. The optical fiber itself is associated with a loss term called the fiber loss coefficient, represented by α . The values of L_{Mux} , L_{Demux} , L_{Switch} and α are treated as constants for a particular network setting. The values of all the gain and loss terms are expressed in decibels (dB). While substituting these values in the expressions, to calculate various power values, they have to be converted into their native units using the conversion:

$$\text{Value in dB} = 10 \log_{10} (\text{Value in units})$$

Also, while computing the fiber loss using α , the term $\alpha*d$ (in dB), where d represents the distance of the link, is to be converted into a unit called *Neper* where

$$1 \text{ Neper} = 4.343 \text{ dB}$$

2.4.3 Estimating Impairments

Expressions for Output Signal & Noise Powers: For the optical fiber shown in Fig. 2.6, the value of output signal power (P_{out}) at the receiver or destination node *RX*, is calculated using the following expression [19]:

$$P_{out} = \frac{G_{amp1} e^{-\alpha d} G_{amp2}}{L_{Switch}^2 L_{Mux} L_{Demux}} P_{in}$$

where P_{in} represents the value of optical signal power at the transmitting node *TX* and d is the distance between the nodes that make up the fiber.

The value of output noise power (N_{out}) at the receiver or destination node *RX*, is calculated using the following expression [19]:

$$N_{out} = \frac{G_{amp1} e^{-\alpha d} G_{amp2}}{L_{Switch}^2 L_{Mux} L_{Demux}} N_{in}$$

where N_{in} represents the value of optical noise power at the transmitting node *TX*.

Expression for ASE Noise Power: ASE noise is added at two points in the optical fiber namely, d and f . Points d and f are on the output side of the optical

amplifiers. The ASE noise generated at point d travels through the fiber, the second amplifier, the demultiplexer and finally the optical cross-connect switch before reaching the destination. Whereas, the ASE noise generated at point f goes through the demultiplexer and the switch. Accordingly, the expressions for the ASE noise power components (generated at d and f) at the receiver node RX are as given below [19]:

$$N_{ASE} = \frac{G_{amp1}F_{amp1}e^{-\alpha d}G_{amp2}}{L_{Switch}L_{Demux}} \frac{hfB_o}{2} + \frac{G_{amp2}F_{amp2}}{L_{Switch}L_{Demux}} \frac{hfB_o}{2}$$

Therefore,

$$N_{ASE} = \frac{G_{amp1}e^{-\alpha d}G_{amp2}}{L_{Switch}L_{Demux}} \frac{hfB_o}{2} X \left(F_{amp1} + \frac{F_{amp2}}{e^{-\alpha d}G_{amp1}} \right)$$

where h is the *Planck's* constant, f is the frequency of the optical signal and B_o is the optical filter bandwidth.

Expression for Crosstalk Noise Power: The Switch Crosstalk noise consists of two components namely, the noise added by the first switch (at point b) and the noise added by the second switch (at point h) respectively.

The noise power ($N_{Switch1}$) due to the first switch, at the end node RX is given by [19]:

$$N_{Switch1} = \frac{G_{amp1}e^{-\alpha d}G_{amp2}}{L_{Switch}L_{Mux}L_{Demux}} \sum_{j=0}^n P_{Sw_j}(\lambda)$$

The noise power ($N_{Switch2}$) due to the second switch, at the end node RX is given by [19]:

$$N_{Switch2} = \epsilon \sum_{j=0}^s P_{Sw_j}(\lambda)$$

where n and s represent the number of optical fibers (carrying optical signals at the same channel λ) crossing the respective switches. $P_{Sw_j}(\lambda)$ is the optical signal power from the j^{th} optical fiber carrying the channel λ . ϵ is the *switch isolation factor* (expressed in dB) [19].

Approximations for XPM and FWM: [19] presents a complex formulation to take into account the effect due to Four Wave Mixing (FWM). It has been widely observed in the literature that, the contribution of FWM to the overall noise is very small compared to other non-linear impairments and is even negligible in certain cases. So, a constant worst case FWM loss, such as the one suggested in [21], could be used for all the links (assuming all channels on the fiber to be active).

The authors in [19], do not consider the effects due to Cross Phase Modulation (XPM) or adjacent channel interference. As an approximation, a constant loss value, similar to the switch isolation factor (ϵ) discussed in the case of switch cross talk (XT) impairment, could be used to account for the first adjacent channel interference.

2.4.4 Computing OSNR (dB) Values

The final step of the analytical model is to compute the value of OSNR at each of the intermediate nodes along a lightpath. For the optical fiber shown in Fig. 2.6, if P_{in} and N_{in} represent the values of signal and noise powers respectively at the transmitter node TX , then the value of $OSNR_{in}$ is given by:

$$OSNR_{in} = 10 \log_{10} \left(\frac{P_{in}}{N_{in}} \right)$$

At the destination node RX , if P_{out} and N_{total} represent the values of signal and total noise powers respectively where

$$N_{total} = N_{out} + N_{ASE} + N_{Switch1} + N_{Switch2} + N_{FWM} + N_{XPM}$$

Then, $OSNR_{out}$ is given by

$$OSNR_{out} = 10 \log_{10} \left(\frac{P_{out}}{N_{total}} \right)$$

A threshold value for the OSNR ($OSNR_{Th}$) is predetermined for a given network. For a lightpath to be feasible under this model, the following condition is checked at all the nodes along the lightpath:

$$OSNR_{out} > OSNR_{Th}$$

If this condition fails at any of the nodes, then the lightpath is considered to be infeasible.

2.5 3R Regeneration

3R regeneration is a popularly used technique in optical networks, to restore the degraded QOT of an optical signal to an acceptable level. Fig. 2.7 gives an overview of 3R regeneration [9]. As shown in Fig. 2.7, the incoming optical signal is first converted to the electronic form (O/E) by the receiver. Three operations are performed on the electronic signal namely *re-amplification*, *re-shaping* and *re-timing* [9]. Since the optical signal is converted back to the electronic domain, the regenerator has the flexibility to choose a different carrier wavelength (equivalently the channel number) when the electronic data is re-converted to the optical signal (E/O) by the transmitter. As a result, a 3R regenerator also provides the wavelength conversion capability at no extra cost.

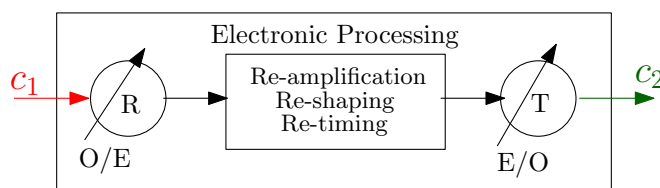

Fig. 2.7: 3R Regeneration

2.6 Types of Optical Networks

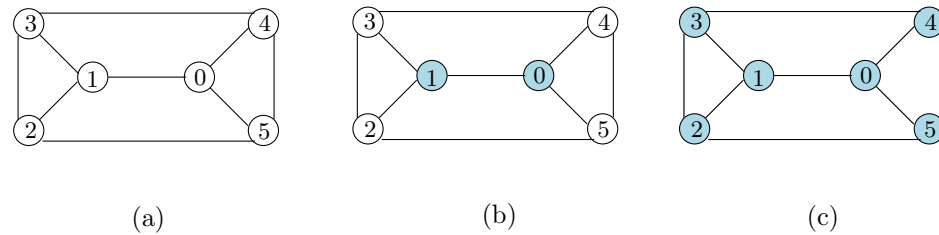

Fig. 2.8: Types of Optical Networks (a) Transparent (b) Translucent (c) Opaque

Based on the usage of 3R regenerators, the optical networks can be classified into 3 types namely [6]:

- Transparent
- Translucent
- Opaque

Transparent or all-optical networks do not use any 3R regenerators and the signal is always in the optical domain. Hence, no OEO conversion is involved in transparent networks. On the other hand, *opaque* networks use 3R regenerators in all the nodes. Using 3R regenerators in the optical network incurs capital and operational costs. At the same time, 3R regenerators offer to reduce the lightpath blocking probability. This leads to a tradeoff between cost saving and network performance.

In recent years a balanced solution in the form of a *translucent* optical network has emerged, in which only a few strategically selected nodes possess 3R regeneration capabilities. Fig. 2.8 shows all the 3 types of optical networks. The shaded nodes in Fig. 2.8 are regeneration capable.

2.7 Designing Translucent Networks

A translucent optical network can be designed for two types of connection requests namely: *static* and *dynamic*. Static connection requests are known in advance to the optical network designer and hence it is possible to determine which nodes may need the regeneration capabilities. Hence, for static requests, the placement of regenerators and the IA-RWA can be performed simultaneously.

Dynamic connection requests are not known a priori to the network operator and are established on the fly as they arrive in the network. Also, the pattern of arrival of these requests cannot be predicted. Therefore it not possible to determine accurately, in advance (i.e. before the network starts operating), the locations to place the regenerators.

The design of a dynamic traffic based translucent optical network involves solving 2 problems namely:

1. Regenerator placement problem (RPP)
2. Routing with regenerator problem (RRP)

The RPP and RRP are discussed in the following sections.

2.7.1 Regenerator Placement Problem (RPP)

The Regenerator placement problem (RPP) [12] is to identify the smallest possible subset of nodes in the network, where 3R regenerators can be deployed. *Optical reach* [10] (the maximum distance an optical signal can travel before it needs 3R regeneration) is a popularly used metric to solve the RPP. The objective of any RPP solution is to identify nodes capable of providing 3R regeneration in such a way that there exists at least one valid route for a translucent lightpath between any two nodes in the network and the length of each of the segments of this translucent lightpath being less than the optical reach. However the limitation of the RPP approaches in

general is that, optical reach is calculated on the basis of linear impairments only. Since the connection requests are dynamic, the non-linear impairments cannot be estimated at the time of solving the RPP.

2.7.2 Routing with Regenerators Problem (RRP)

The Routing with regenerators problem (RRP) [12] is to establish, if possible, a transparent or a translucent lightpath for every new connection request, using the regenerators deployed in the RPP stage. The objective of RRP is to perform the IA-RWA itself. Every dynamic connection request has a known duration of communication and after this duration is over it is important to take down the corresponding lightpath and reclaim the allocated resources (wavelengths and regenerators, if any). An important consideration in RRP is that, whenever a new lightpath is established, the existing lightpaths in the network should not be disturbed. In other words, the non-linear impairments generated due to the interaction between the new and existing lightpaths should be taken into account while performing IA-RWA. It is to be noted that the RPP is solved prior to network operation and RRP is carried out during network operation. The placement of regenerators obtained by solving the RPP is given as an input to the RRP stage.

2.8 Related Works on RRP

This section presents a review of the previous works on the routing with regenerators problem (RRP). All the RRP approaches, reviewed in this section, assume a given sparse placement of regenerators before the network starts operating.

Yang et al. 2005 [9]: For each new incoming connection request, weights are assigned to the network edges based on the availability of regenerators and channels. Then Dijkstra's shortest path algorithm is used to find the shortest route from the source to destination of the new request. The first fit approach is used for wavelength

assignment. If the shortest route and first fit wavelength provide a feasible solution, the heuristic return success. Otherwise it returns a failure. Non-linear impairments are not considered in [9] while estimating the QOT of the optical signal.

Yannuzzi et al. 2009 [14]: The authors in [14] proposed an IA-RWA algorithm called *predictive routing according to the Q-factor* (PR-Q). A limited set of potential routes is precomputed for each incoming connection request. The routes in this set are sorted in the increasing order of total distance and edge sharing among lightpaths. The Q-factor of the optical signal is measured for each of the routes in the constructed set by assigning the available wavelengths. The first route, which satisfies the Q-factor requirements, is chosen as the IA-RWA solution for the connection request. The PR-Q algorithm returns a failure if none of the routes, in the precomputed set, are feasible. Non-linear impairments are considered in the Q-factor using an indirect model.

Pachnicke et al. 2009 [15]: The worst case non-linear impairments are assigned as weights to the network edges. For each new connection request, a set of $k = 3$ shortest routes (edge-disjoint) is precomputed. The Q-factor is estimated for each of the precomputed routes. If none of the routes offer a feasible Q-factor, the connection request is blocked.

Subir et al. 2009 [12]: A candidate set of m paths is pre-computed for every node pair. Then the A* [13] Best First search algorithm is used to select the route for the new connection request. Non-linear impairments are not considered while estimating the QOT of the optical signal. Only optical reach is used to estimate the physical layer impairments.

Tordera et al. 2009 [16]: The authors in [16] proposed an IA-RWA algorithm called, *Minimum Coincidence and Distance according to Q factor* (MINCOD-Q). A set of k routes are precomputed from the source to destination of the new connection request. The k routes are sorted in the increasing order of distance and edge sharing among lightpaths. First fit wavelength assignment is used. the Q-factor is computed

for all the routes. MINCOD-Q returns success if there is atleast one feasible route (in terms of Q-factor) among the k routes considered.

Manousakis et al. 2010 [17]: The authors in [17] proposed an IA-RWA algorithm for translucent networks that proceeds in 2 phases. The first phase includes computing a set of non-dominated candidate paths for the new connection request. In the second phase a path is chosen from the constructed set based on several policies including:

- Most used wavelength, better Q-factor & wavelength utilization.
- Best Q-factor performance.
- Least regenerators usage & most used wavelengths.
- Least regenerators usage and best Q-factor.
- Least regenerators usage and better Q-factor and Most Used Wavelengths.

If a feasible path cannot be found from the set, the algorithm blocks the new connection request.

Zhao et al. 2012 [18]: A set, P' , of up to k paths is constructed for every node pair in the network, even before the network operation begins. When a new connection request arrives, the corresponding set, P' , for the (source,destination) pair of the request is fetched. A subset of paths, P , is constructed from P' using a number of strategies including the shortest distance, the optical reach and the availability of regenerators. The QOT of each of the paths in set P is computed. If there exists a path with satisfactory QOT, the algorithm return the solution. Otherwise the connection request is blocked.

3 BEST FIRST SEARCH RWA (BFS-RWA)

This section presents the proposed *BFS-RWA* approach to solve the Routing with Regenerators Problem (RRP). BFS-RWA uses the A^* [13] *best first search* Algorithm to perform IA-RWA. Existing RRP approaches⁴ use a limited set of potential routes for a lightpath, while performing IA-RWA, which leads to an incomplete exploration of the solution space. On the other hand, BFS-RWA performs an exhaustive search and leaves no route unexplored in order to establish the connection request. Also, BFS-RWA is the first approach to guarantee an optimal solution (i.e a solution using the least possible number of regenerators), if it exists. In other words, BFS-RWA gives a solution, if it exists and this solution is optimal.

BFS-RWA works by constructing a search tree to find a feasible IA-RWA solution for every new connection request from any source s to any destination d . The search starts by making the source node as the root of the search tree. The search continues until i) either d is reached and we conclude that there does not exist a better solution, or ii) we conclude that the destination d cannot be reached (either due to unavailability of channel (s) or due to physical layer impairments).

In order to distinguish between the physical network topology and the search tree, the term “route” is used to denote the sequence of fiber (s) used by a lightpath from s to d in the physical topology and the term “path” is used to denote the edges in the search tree from the root node (which corresponds to s) to the node, in the search tree, corresponding to d . The BFS-RWA looks for the most “promising” path in the search tree in order to determine the best possible route, from s to d , for the lightpath. BFS-RWA approach uses the OSNR model outlined in Section 2.4, to estimate the QOT of the optical signal. Subsequent sections described the BFS-RWA in detail.

⁴Explained in Section 2.8

3.1 Notation used in BFS-RWA

s (d) : the source (destination) of the new request for communication.

\mathbb{N} : the set of nodes in the physical topology equipped with 3R regenerators.

t^h : the best node in the search tree whose neighborhood is being explored.

n (t^n) : a node in the physical topology (search tree) that is currently being considered, where n is adjacent to h .

N_{reg}^n : number of regenerators used in the path from t^s to t^n .

\mathcal{A}_{t^n} : the actual cost to go from node s to n , using the path from t^s to t^n .

\mathcal{H}_{t^n} : the estimated cost to go from node n to d .

\mathcal{T}_{t^n} : the total estimated cost to go from s to d through n , using the path from t^s to t^n through t^n .

$OSNR_{t^n}(OSNR_{in})$: the OSNR value at node t^n (t^s or at any node where the lightpath undergoes regeneration).

$OSNR_{Threshold}$: the minimum acceptable OSNR value.

D_d^n : the length of the shortest route from n to d .

\mathcal{N} : set of potential next nodes for the search.

\mathcal{L} : RWA solution for communication from s to d .

r : the optical reach.

\mathcal{C}_{t^n} : a list of valid channel numbers for the segment to t^n .

Ψ : the list of segments in the proposed lightpath, where Ψ^k denotes the k^{th} segment of Ψ , where the first segment starts from s .

num_segments : number of segments in Ψ .

PIG : the path intersection graph for the lightpath under consideration.

c : a channel number.

heuristic_cost(t^x) (actual_cost(t^x)) : function to compute the heuristic (actual) cost using equation 3 (4), given in section 3.2.

assign_channel(Ψ^k, c) : function assign channel *c* to segment Ψ^k .

calculate_OSNR_value(Ψ) : function to calculate, the QOT of all existing lightpaths as well as the proposed lightpath. It returns the lowest OSNR value among all these lightpaths.

check_for_shared_edges(Ψ) : function that returns true only if there is at least one common edge in any two segments of Ψ .

create_path_intersection_graph(Ψ) : function to create a path intersection graph, considering all the segments in Ψ .

colorable(PIG) : function that returns true if graph *PIG* can be colored.

create_node(t^h, n) (create_regenerator_node(t^h, n)) : function to create node (regenerator node) t^n , and insert it into the search tree as a child of node t^h . The function returns node t^n .

create_root_node(s) : function to create the root node t^s . The function returns t^s .

find_best_node_in_tree() : function that retrieves the leaf node t^h in the tree having the least total cost.

find_eligible_neighbours(t^h) : function to find all valid child nodes of t^h .

lightpath_feasible(t^h, t^n) : function that returns true iff the path from t^s to t^n through t^h may be used to set up a lightath from s to n .

generate_RWA_solution_using_search_tree(t^h) : function that returns the routes and the channels assigned to the segments of the new translucent lightath from s to d .

3.2 Details of BFS-RWA

3.2.1 Actual and Heuristic Costs

Each node t^n in the search tree includes the following information:

1. a reference to node n in the physical topology.
2. Two types of costs, i) the actual cost \mathcal{A}_{t^n} , and ii) the heuristic cost \mathcal{H}_{t^n} .
3. If $n \in \mathbb{N}$, whether 3R regeneration is carried out at t^n , to handle this request.
4. The list of channel numbers \mathbb{C}^n that may be used in the segment to node n .

It is to be noted that, in general, a number of nodes (t^x) in the tree may refer to the same node x in the physical topology. This is because a) the tree, in general, involves multiple routes from s to d , through node x and b) the route of the lightpath may involve loops as shown in Fig. 1.2.

Since the objective of BFS-RWA is to minimize the total number of regenerators used, the actual (\mathcal{A}_{t^n}) and heuristic (\mathcal{H}_{t^n}) costs are determined in terms of the number of regenerators required as follows:

$$\mathcal{A}_{t^n} = N_{Reg}^n + \frac{OSNR_{in} - OSNR_n}{OSNR_{in} - OSNR_{Threshold}} \quad (3)$$

$$\mathcal{H}_{t^n} = \frac{D_d^n}{r} \quad (4)$$

$(OSNR_{in} - OSNR_{Threshold})$ is the amount of degradation in OSNR value before regeneration is needed. The ratio in (3) measures, in terms of a fraction of a regenerator, the extent of signal degradation in the current segment. The sum in Equation (3) represents the actual cost, in terms of the total number of regenerators required from t^s to t^n . The total estimated cost to go from node t^s to t^d through node t^n is $\mathcal{T}_{t^n} = \mathcal{A}_{t^n} + \mathcal{H}_{t^n}$, which guides the search in the A* algorithm. The A* algorithm guarantees an optimal solution (if it exists), if the heuristic used to guide the search is admissible [13].

Lemma 1. *The cost, \mathcal{H}_{t^n} , is an admissible heuristic.*

Proof. The numerator, D_d^n , in Equation (4) is the distance of the shortest route from n to d , so that the actual route used to go from n to d is at least as long as D_d^n . The denominator uses the optical reach r and hence ignores all class 2 impairments. If both class 1 and class 2 impairments are considered, the extent of signal degradation increases and hence the distance the signal can travel along fibers is further reduced. Therefore, r represents an upper bound. Hence, the heuristic cost, \mathcal{H}_{t^n} , gives a lower bound for the number of regenerators required to reach d from n . In other words, \mathcal{H}_{t^n} is an admissible heuristic. \square

3.2.2 Main Algorithm

In lines 1 – 2, the BFS-RWA (**Algorithm 1**) starts with node t^s as the root of the search tree. Line 3 sets the stage for the following iterative process, where t^h denotes the node whose neighborhood will be explored. Lines 5 – 27 describe how the node, t^h , will be expanded. In line 5, $find_eligible_neighbours(t^h)$, finds the set of nodes adjacent to h in the physical topology and excludes from the set all nodes x such that a) there is no channel that is currently unused on the link $h \rightarrow x$, or b) t^x is an ancestor of t^h and appears in the same segment as t^h .

Algorithm 1 BFS-RWA

Input: New Request: $\mathcal{R} = (s, d)$, Network Topology, \mathbb{N} (the set of regenerator nodes), Network State

Output: RWA Solution (if lightpath established), NULL (otherwise)

```
1:  $t^s \leftarrow \text{create\_root\_node}(s)$ 
2:  $\mathcal{T}_{t^s} \leftarrow \text{heuristic\_cost}(t^s)$ 
3:  $t^h \leftarrow \text{find\_best\_node\_in\_tree}()$ 
4: while (true) do
5:    $\mathcal{N} \leftarrow \text{find\_eligible\_neighbours}(t^h)$ 
6:   for each  $n \in \mathcal{N}$  do
7:      $t^n \leftarrow \text{create\_node}(t^h, n)$ 
8:     if ( $\text{lightpath\_feasible}(t^h, t^n)$ ) then
9:        $\mathcal{A}_{t^n} \leftarrow \text{actual\_cost}(t^h, t^n)$ 
10:       $\mathcal{H}_{t^n} \leftarrow \text{heuristic\_cost}(t^n)$ 
11:       $\mathcal{T}_{t^n} \leftarrow \mathcal{A}_{t^n} + \mathcal{H}_{t^n}$ 
12:      if ( $n \in \mathbb{N}$ ) then
13:         $t^n \leftarrow \text{create\_regenerator\_node}(t^h, n)$ 
14:         $\mathcal{A}_{t^n} \leftarrow \lceil \text{actual\_cost}(t^h, t^n) \rceil$ 
15:         $\mathcal{T}_{t^n} \leftarrow \mathcal{A}_{t^n} + \mathcal{H}_{t^n}$ 
16:      end if
17:    else
18:       $\text{delete\_node}(t^n)$ 
19:    end if
20:  end for
21:   $t^h \leftarrow \text{find\_best\_node\_in\_tree}()$ 
22:  if ( $t^h$  is NULL) then
23:    return NULL // The request for communication has to be blocked.
24:  else if ( $\text{reached\_destination}(t^h)$ ) then
25:     $\mathcal{L} \leftarrow \text{generate\_RWA\_solution\_using\_search\_tree}(t^h)$ 
26:    return  $\mathcal{L}$  // The request can be handled using the lightpath  $\mathcal{L}$ 
27:  end if
28: end while
```

find_eligible_neighbours allows a node x to appear more than once in a translucent lightpath if these occurrences are in different segments (Fig. 1.2 shows an example). However, a loop in the same segment cannot happen.

Lines 6 – 20 define an iterative process, which has to be repeated for each element in \mathcal{N} . In line 8, *lightpath_feasible*(t^h, t^n) checks whether it is feasible (in terms of channel assignment and QOT) to set up a lightpath, using a path from t^s to t^n through t^h , in the presence of all other existing lightpaths. If so, lines 9 – 11 compute

the total cost of node t^n . Lines 12 – 16 consider the possibility that node n is capable of 3R regeneration. If so, another child of node t^h is created (line 13). This new child of t^h uses 3R regeneration and starts a new segment, having a OSNR value of $OSNR_{in}$. The ceiling function in line 14 means that the second term in Equation 3 is replaced by 1. If the condition in line 8 is not satisfied, it means that t^n created in line 7 cannot be a child of t^h and is deleted in line 18.

Line 21 finds the next best node, t^h , to explore (i.e., the leaf node with the least total estimated cost). If this node cannot be found, the search has failed (line 23). If node t^h corresponds to d , the search terminates and returns the RWA solution (i.e., the route and the channel number(s) for all segment(s)).

3.2.3 Lightpath Feasibility, Channel Assignment and Existence of Loops

Algorithm 2 describes function *lightpath_feasible*(t^h, t^n) and is discussed below. As mentioned before, every node (t^x) in the search tree maintains a list of channels, (\mathbb{C}_{t^x}), which can be assigned to the segment, ending in node t^x . In lines 1 – 5, the intent is to determine the set of channels, \mathbb{C}_{t^n} (i.e., the set of channels for the last segment so far). Those channels that are in use on the fiber $h \rightarrow n$, cannot be assigned to this segment. If node t^h is being used for regeneration (lines 1 – 2), a new segment starts from t^h . Otherwise (lines 3 – 4), the same segment from t^h continues to node t^n . In line 6, function *construct_transparent_segments*(t^s, t^n), returns the set, Ψ , of all transparent segments (Ψ) of the proposed translucent lightpath.

Lines 7 – 12 define an iterative process, which is repeated for every channel in set \mathbb{C}_{t^n} . In line 8, *assign_channel*($\Psi^{num_segments}, c$) assigns channel c to the last segment ($\Psi^{num_segments}$) of the proposed lightpath. In line 9, the OSNR tool⁵ determines the feasibility of the proposed lightpath. The OSNR tool has access to the network state information, which includes the set of existing lightpaths. The OSNR tool measures

⁵OSNR tool is an implementation of the OSNR model reviewed in Section 2.4 and is discussed in detail in Section 4.6.

the degradation of optical signals in all the lightpaths (including the new lightpath under consideration and the existing lightpaths) and returns the final OSNR value of the optical signal that has degraded the most. If this OSNR value is less than the $OSNR_{Th}$ for the network, then there is at least 1 lightpath that is infeasible. Therefore, channel c is not a valid assignment for $\Psi^{num_segments}$, and is excluded from \mathbb{C}_{t^n} in line 10.

After these iterations, if \mathbb{C}_{t^n} becomes empty (line 13), it means that node t^h cannot be expanded to t^n in the search tree and $lightpath_feasible(t^h, t^n)$ returns false. Otherwise, it means that channels are available to go from t^h to t^n .

At this stage, the proposed lightpath is checked to see if any edge is shared by two or more segments (line 16). If there is at least one such shared edge, the technique described in [12] is used to ensure that such segments are not assigned the same channel. As done in [12], a path intersection graph (*PIG*) is created and list coloring [22] is used to color the graph (lines 17 – 20). The segments of the proposed lightpath become nodes in the *PIG* and any 2 nodes in the *PIG* are connected by a link if the corresponding segments share an edge. Each node in the *PIG* is assigned a list of colors, where each color represents a channel that may be used for the corresponding segment. The objective of list coloring is that each node in the *PIG* should be colored, using one of the colors in the list for that node, such that no two adjacent nodes (connected by an edge) have the same color. If the list coloring is successful, it means a valid channel assignment is possible for all the transparent segments and $lightpath_feasible(t^h, t^n)$ returns true (Line 19). Otherwise, it returns false (Line 21).

Algorithm 2 $\text{lightpath_feasible}(t^h, t^n)$

Output: true (if feasible), false (otherwise)

```
1: if ( $t^h$  is used for 3R-regeneration) then
2:    $\mathbb{C}_{t^n} \leftarrow \{ c \mid c \text{ is an unused channel on fiber } h \rightarrow n \}$ 
3: else
4:    $\mathbb{C}_{t^n} \leftarrow \mathbb{C}_{t^h} - \{ c \mid c \text{ is a used channel on fiber } h \rightarrow n \}$ 
5: end if
6:  $(\Psi, \text{num\_segments}) \leftarrow \text{construct\_transparent\_segments}(t^s, t^n)$ 
7: for each  $c \in \mathbb{C}_{t^n}$  do
8:    $\text{assign\_channel}(\Psi^{\text{num\_segments}}, c)$ 
9:   if ( $\text{calculate\_OSNR\_value}(\Psi) < \text{OSNR}^{\text{Threshold}}$ ) then
10:     $\mathbb{C}_{t^n} \leftarrow \mathbb{C}_{t^n} - \{c\}$ 
11:   end if
12: end for
13: if ( $\mathbb{C}_{t^n}$  is  $\emptyset$ ) then
14:   return false
15: else
16:   if ( $\text{check\_for\_shared\_edges}(\Psi)$ ) then
17:     $\text{PIG} \leftarrow \text{create\_path\_intersection\_graph}(\Psi)$ 
18:    if ( $\text{colorable}(\text{PIG})$ ) then
19:     return true
20:    end if
21:   return false
22: end if
23: return true
24: end if
```

3.3 Example

Let there be a new connection request from $s = 3$ to $d = 5$ for the network given in Fig. 3.1. Fig. 3.2(a) shows the search tree, constructed using BFS-RWA, after a few iterations of the while loop starting at line 4 of Algorithm 1. Each node in the tree is shown using a circle enclosing the corresponding node number in the physical topology. The total estimated cost for each node is shown beside the node. A shaded node denotes that 3R regeneration will take place at that node. Additionally, selected nodes have been shown with a unique label (e.g., A, B, C) for convenience. Nodes

marked with a X^6 in Fig. 3.2(a) are those that cannot be explored further in the search tree, either due the unavailability of channels (network layer constraints), or because of unacceptable QOT (physical layer limitations).

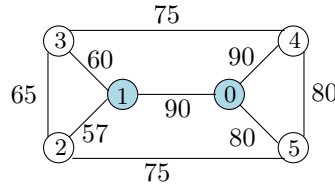

Fig. 3.1: A 6 node translucent optical network

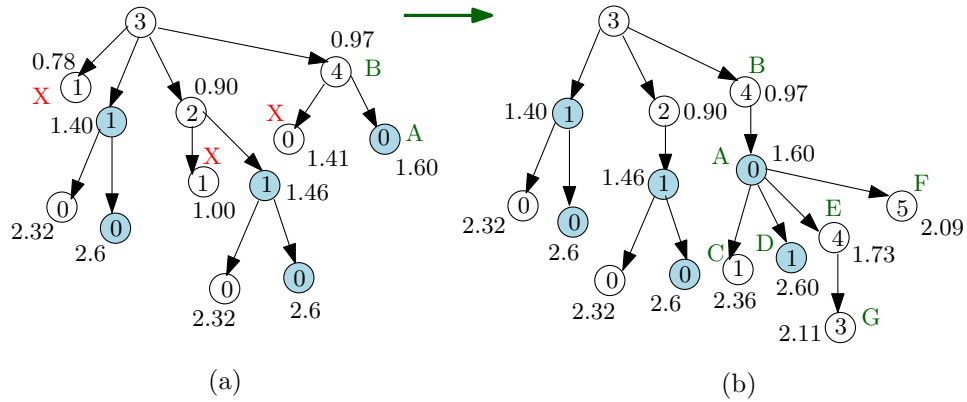

Fig. 3.2: Search tree after generating (a) node labelled A (b) node labelled G

Table 3.1: List of existing lightpaths

<i>Lightpath Num.</i>	<i>Route</i>	<i>Channel</i>
<i>L1</i>	$3 \rightarrow 1 \rightarrow 2$	c^0
<i>L2</i>	$1 \rightarrow 0$	c^1
<i>L3</i>	$3 \rightarrow 2$	c^0
<i>L4</i>	$2 \rightarrow 5$	c^1
<i>L5</i>	$4 \rightarrow 5$	c^0
<i>L6</i>	$4 \rightarrow 5$	c^1
<i>L7</i>	$1 \rightarrow 3$	c^0
<i>L8</i>	$1 \rightarrow 3$	c^1
<i>L9</i>	$1 \rightarrow 2$	c^1

⁶Since nodes marked with a X in Fig. 3.2(a) correspond to nodes that cannot be explored further, they have been omitted from Fig. 3.2(b).

Table 3.1 shows the lightpaths in existence at the time when this new connection request is processed. Each fiber in the network supports 2 channels (c^0, c^1).

For the tree shown in Fig. 3.2(a), the node with label A has a total estimated cost of 1.60, which is the least among all leaf nodes in the tree. Therefore, in line 21 of Algorithm 1, *find_best_node_in_tree()* returns node A , so that t^h has $h = 0$ and $\mathcal{T}_{t^0} = 1.60$. The conditions in lines 22 and 24 are not satisfied, so the next iteration of the while loop begins by exploring node A .

Since A is shaded, a new segment starts from A . The set of nodes adjacent to node 0 in the physical topology is $\{1,4,5\}$. We note that node B in Fig. 3.2(b) is an ancestor of A but appears in a different segment. Therefore, node 4 cannot be excluded from \mathcal{N} . Hence, in line 5, *find_eligible_neighbours(t^0)* returns set $\mathcal{N} = \{1, 4, 5\}$. When $n = 1$, line 7 creates node C of Fig. 3.2(b). Function *lightpath_feasible(t^0, t^1)*, in line 8, returns true, so that lines 9 – 16 will be executed. In lines 9 – 11, the total estimated cost, for C , is calculated to be $\mathcal{T}_{t^1} = 2.36$. Since node 1 is capable of 3R regeneration, the condition in line 12 is satisfied. In lines 13 – 15, node D is created in a way similar to that for C . The process for $n = 4$ ($n = 5$) is similar to that for C , giving node E (F) of Fig. 3.2(b). Since neither of the nodes 4 and 5 are capable of 3R regeneration, lines 13 – 15 are not applicable for E and F .

Even though node F in the search tree refers to the destination node 5 in the physical topology, the search proceeds, since the least cost node is currently E which will be selected for further exploration. In the next iteration, node G becomes a child of E , in a way just like C . In the following iteration, the lowest cost node is F . Since F refers to the destination node 5, the search has found the optimal solution. The routes for the segments of the established translucent lightpath are $3 \rightarrow 4 \rightarrow 0$ and $0 \rightarrow 5$. The channels assigned to these segments are c^1 and c^0 respectively. In line 25, this information is returned by *generate_RWA_solution_using_search_tree(t^5)*.

Fig. 3.3(a) shows a sample translucent optical network, with nodes 4 and 7 capable

of 3R regeneration. Fig.3.3(b) shows the path intersection graph (PIG) constructed by BFS-RWA for a translucent lightpath, from source = 1 to destination = 8 (given in Table 3.2), in the network shown in Fig. 3.3(a). Fig. 3.3(b) also shows the list of available channels (or colors in terms of list coloring) adjacent to every node in the PIG. An optical reach of 300 km is assumed in this example. It can be observed from Table 3.2, that the segments P_1 and P_2 share the edge $2 \rightarrow 3$. Hence a loop exists in the translucent lightpath. Therefore there is an edge connecting P_1 and P_2 in the PIG. Segment P_3 does not share an edge with either P_1 or P_2 and hence is disconnected from P_1 and P_2 in the PIG.

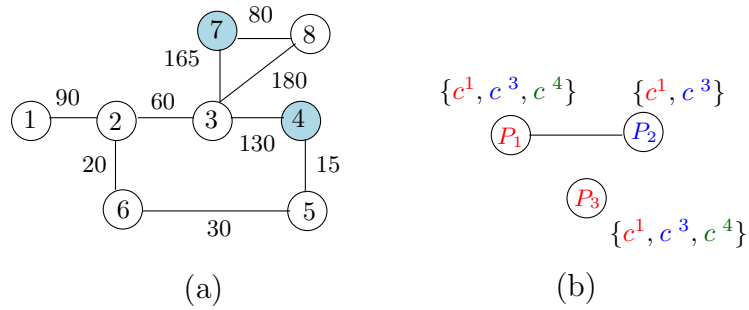

Fig. 3.3: (a) A sample translucent network (b) Path Intersection Graph (PIG)

Table 3.2: Transparent segments of a lightpath with loops

<i>Segment num.</i>	<i>Route</i>	<i>Available Channels</i>
P_1	$1 \rightarrow 2 \rightarrow 3 \rightarrow 4$	$\{c^1, c^3, c^4\}$
P_2	$4 \rightarrow 5 \rightarrow 6 \rightarrow 2 \rightarrow 3 \rightarrow 7$	$\{c^1, c^3\}$
P_3	$7 \rightarrow 8$	$\{c^1, c^3, c^4\}$

The list coloring performed on the PIG shown in Fig. 3.3(b), should ensure that nodes P_1 and P_2 get different colors (or channels). Segment P_3 can be assigned any channel from its corresponding list. The PIG in this case is colorable and hence a valid solution.

4 TEST BENCH FOR SIMULATION

Simulation is a popular technique used to study the behaviour of computer networks, without having to setup the network physically and simulator is a piece of software that imitates the working of a computer network. This section presents details of the network simulator used to study various aspects of the proposed BFS-RWA approach.

4.1 Simulator Overview

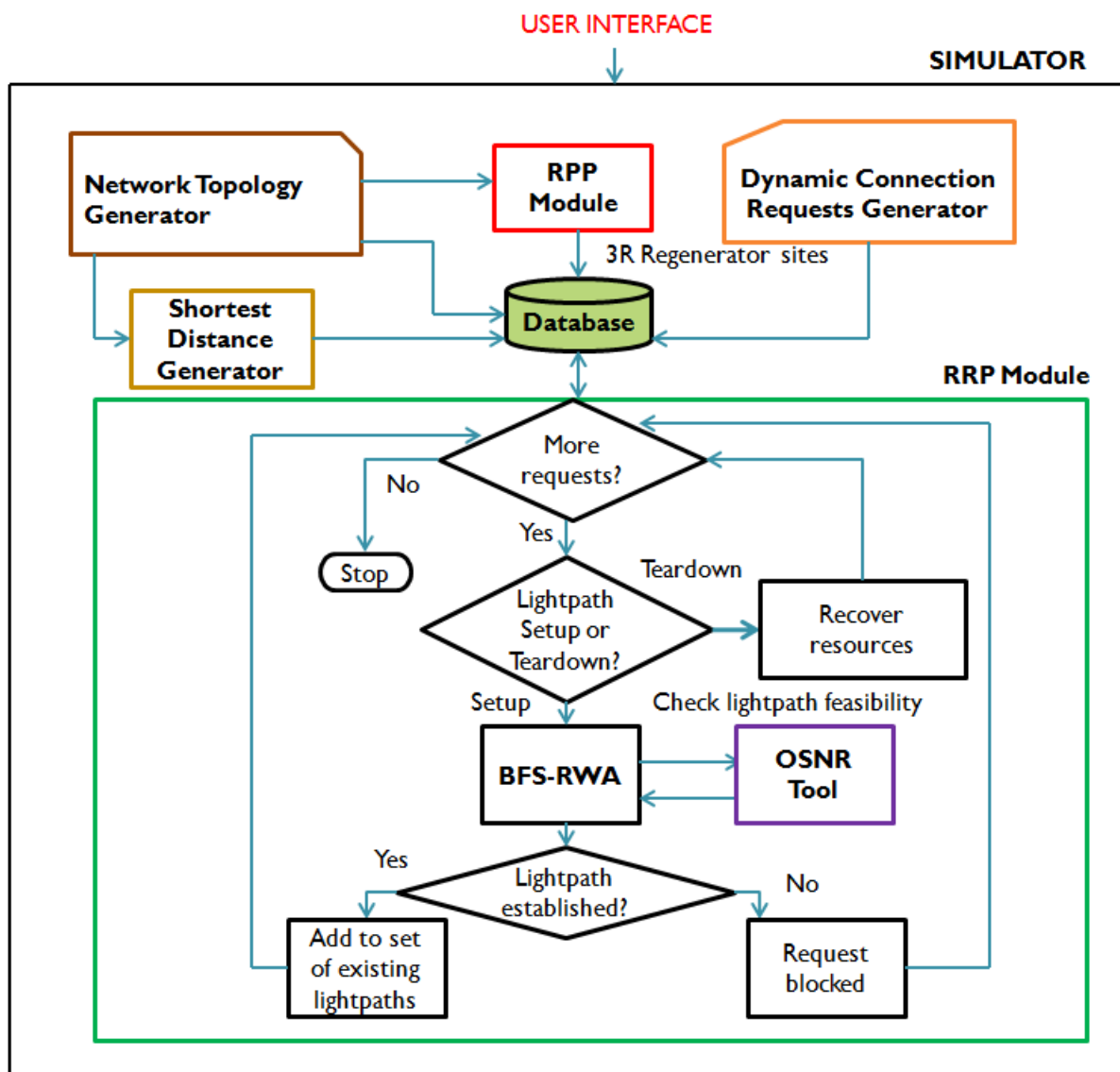

Fig. 4.1: BFS-RWA Simulator block diagram

Fig. 4.1 shows a block diagram of the simulator used for testing the BFS-RWA approach. Table 4.1 summarizes the main components of the simulator.

Table 4.1: Summary of simulator components

Component	Functionality
Network topology generator	Generates a synthetic network topology with the given number of nodes
Shortest distance generator	Generates the shortest distance between every pair of nodes in the network.
Dynamic connection requests generator	To generate the dynamic connection requests for the simulation
RPP module	To identify a subset of nodes in the network that will have regeneration capabilities.
OSNR tool	To determine feasibility of the new lightpath to be established. Also checks the feasibility of the existing lightpaths.
RRP Module	To run the simulation and generate result

In order to run a simulation, the following input parameters need to be supplied through the *user interface*:

- Number of nodes in the network topology (in case of synthetic network) or the name of the real network topology.
- In the case of a synthetic network, a network case number.
- The target traffic load of dynamic connection requests (in Erlangs).
- A traffic case number.
- Maximum number of channels available in each fiber.
- Optical reach value.

- Maximum number of regenerators at each of the nodes to be identified later by the RPP module.

The simulator has access to a database which is used to store information (in separate files) generated by the components mentioned in Table 4.1. When a simulation is initiated by the user interface, the simulator first checks for the required input files in the database. In case a required file is not found, the respective simulator component is invoked to generate the file. The RRP module is the starting point for network operation, which takes its input from the database. Each simulation refers to executing one complete sequence of dynamic connection requests for a given network topology. The RRP module finally writes the simulation result back to the database. The simulation result includes the following information:

- A file containing the IA-RWA solution of every connection request that is established.
- Lightpath blocking probability⁷.
- Percentage of translucent lightpaths in the total number of lightpaths established.
- Execution time of the simulation.
- The maximum number of regenerators used at every regeneration capable node.

In order to predict the behaviour of a network accurately, several simulations of the same kind need to be run. For a given number of nodes in the network, different topologies need to be considered. Similarly for a given traffic load value, different connection request sequences need to be used. The network and traffic case numbers provided by the user enable the simulator to uniquely identify the topology and connection request sequence respectively for this purpose.

⁷Explained in Section 5

The simulator software was developed in C language. The source code was compiled using gcc on Debian GNU/Linux operating system. IBM CPLEX [23] studio was used to solve the ILP optimization problem in the RPP module.

The following subsections discuss in detail, the working of each of the simulator components mentioned in Table 4.1.

4.2 Network Topology Generator

In order to perform a simulation the starting point is a network topology. Two types of network topologies are considered for the simulations namely:

- Real network topologies
- Synthetic network topologies

Real network topologies exist physically and are currently being used for communication. The synthetic topologies do not exist physically and are generated for experimental purpose. The *Network topology generator* component of the simulator, shown in Fig. 4.1, is used to generate synthetic network topologies. The input to the generator is the number of nodes in the network topology. The user can configure the lengths of the edges connecting the nodes, to lie between a minimum and a maximum value. In addition, the maximum degree of each node in the network topology (i.e the number of bi-directional edges associated with each node) can also be configured. The generated synthetic topology is represented in the form of a 2 dimensional matrix.

The matrix (M) corresponding to the network topology shown in Fig. 4.2, is given in Table 4.2. If there exists an edge between 2 nodes (i and j) in the network, then the corresponding edge length is entered in $M^{i,j}$, otherwise a -1 is used for no edge. The network configuration parameters used for the simulations are given in Table 4.3.



Fig. 4.2: A sample network topology with 6 nodes

Table 4.2: Network topology matrix

-1	90	-1	-1	60	80
90	-1	57	60	-1	-1
-1	70	-1	65	-1	75
-1	60	65	-1	75	-1
90	-1	-1	75	-1	80
80	-1	75	-1	80	-1

Table 4.3: Network configuration parameters

Parameter	Value
Maximum Node Degree	3
Minimum Edge Length	50 km
Maximum Edge length	110 km

4.3 Shortest Distance Generator

As explained in Section 3.2.1, BFS-RWA uses the shortest distance between the node under consideration and the destination node, to calculate the heuristic cost (Eqn.4 in Section 3.2.1). The shortest distance generator component of the simulator uses the Dijkstra's algorithm [24] to generate the shortest distance between every pair of nodes, for a given network topology. The shortest distance information is stored in the form of a 2 dimensional matrix (D) in the database. $D^{i,j}$ gives the shortest distance between nodes i and j . As an example, Table 4.4 gives the shortest distance matrix for the network topology shown in Fig. 4.3.

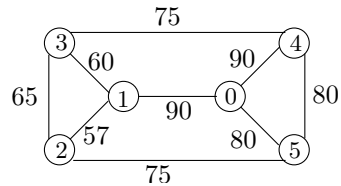

Fig. 4.3: A sample network topology with 6 nodes

Table 4.4: Shortest distance matrix

0	90	147	135	60	80
90	0	57	60	135	132
155	70	0	65	140	75
150	60	65	0	75	140
90	135	140	75	0	80
80	145	75	140	80	0

4.4 Dynamic Connection Requests

The BFS-RWA approach is designed to handle dynamic lightpath connection requests. The *Dynamic connection requests generator* component of the simulator is used to generate connection requests dynamically. Each connection request has the following attributes:

- unique connection request number
- source node
- destination node
- start time
- duration

If the connection request is established, then the corresponding lightpath is taken down at the time given by (start time + duration). In order to facilitate the simulation, for each connection request, 2 events are generated namely the connection setup event and the connection teardown event. The teardown event is executed only if the setup event is successful. The source and destination nodes of each of the connection requests are generated randomly. Table 4.5 shows a sample sequence of setup and teardown events for 3 connection requests.

The traffic load of connection requests is measured in terms of a unit called *Erlang*, which can be defined as the product of average request arrival rate and the average request duration. Eqn. 5 gives the expression for traffic load, where the unit time and average request duration are both measured in the same unit of time.

Table 4.5: Connection setup and teardown events sequence

Connection Request Num	Event Type	Source Node	Destination Node	Start Time
1	Setup	1	6	0.00
2	Setup	3	5	2.50
1	Teardown	1	6	3.00
3	Setup	2	3	4.00
3	Teardown	2	3	5.00
2	Teardown	3	5	6.00

$$Traffic \text{ (in Erlangs)} = \left(\frac{No. \text{ of requests}}{Unit \text{ time}} \right) * Avg. \text{ request duration} \quad (5)$$

An average request duration of 3 minutes was used in the simulations. A unit time period of 60 minutes was used for the arrival of connection requests. The traffic load was varied by changing the no. of connection requests. As an example, for a traffic load of 30 Erlangs, the number of connection requests would be 600, with an average request arrival rate of 10 requests/min.

Whenever events occur at an average rate in a fixed interval of time, they form a *Poisson* process. In probability theory, a Poisson distribution is used to model such events. The arrival times of dynamic connection requests form a Poisson process since the requests arrive at an average rate over a fixed time period of 60 minutes. The Dynamic connection requests generator produces a sequence of connection requests following a Poisson distribution, using the technique suggested in [25]. Similarly an exponential distribution was used to generate the durations of the connection requests.

4.5 RPP Module

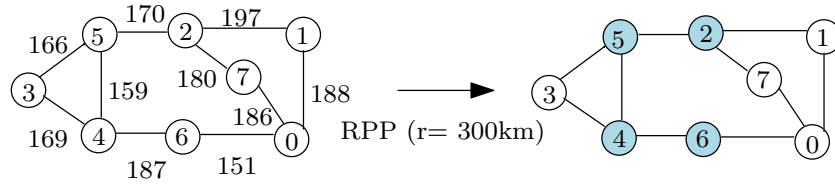

Fig. 4.4: RPP solution based on optical reach for a random network topology

The Regenerator Placement (RPP) module of the simulator is responsible for identifying the smallest possible subset of nodes in the network, that will have 3R regeneration capabilities. This RPP module is based on the dissertation work presented in [26] and uses optical reach as the metric to identify the regeneration capable nodes. The RPP approach presented in [26], does not consider non-linear impairments while identifying the regeneration capable nodes. The inputs to the RPP module include, the physical network topology (in the form of a matrix presented in Table 4.2) and the optical reach. The objective is to identify nodes capable of providing 3R regeneration in such a way that, there exists a route for a translucent lightpath between any two nodes in the network and the lengths of the segments of this translucent lightpath are less than the optical reach. It constructs an integer linear program (ILP) for the given network topology and optical reach and solves the ILP using a branch and cut based optimization technique [26]. IBM ILOG CPLEX [23] software and its callback features are used to solve the ILP. Fig. 4.4 shows a randomly generated network topology, consisting of 8 nodes, and the corresponding regenerator placement obtained using the RPP module of the simulator. The shaded nodes in Fig. 4.4 are regeneration capable and an optical reach value of 300 km has been used in this example.

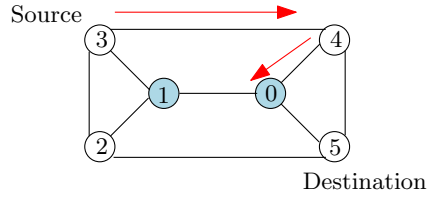

Fig. 4.5: Sample network topology

Table 4.6: List of existing lightpaths

<i>L.Num</i>	<i>Route</i>	<i>Channel(s)</i>
<i>L1</i>	$3 \rightarrow 1^R \rightarrow 2 \rightarrow 5$	c^0, c^1
<i>L2</i>	$1 \rightarrow 0$	c^1
<i>L3</i>	$4 \rightarrow 0^R \rightarrow 5$	c^0, c^0

4.6 OSNR Tool

The OSNR tool module in the simulator is based on the OSNR analytical model presented in Section 2.4. The OSNR tool is used to estimate the physical layer impairments (PLI) and determine the extent of optical signal degradation in a lightpath. As shown in Fig. 4.1, the OSNR tool is invoked several times, as required, by the BFS-RWA module to determine the feasibility of lightpaths. A lightpath is said to be feasible, if the OSNR value of the propagating optical signal is above the predetermined threshold value ($OSNR_{Th} = 23$ dB) at every node along the lightpath.

The non-linear impairments (explained in section 2.3.2) arise due to the interference between the new lightpath to be established and the existing lightpaths in the network. As a result, the new lightpath can cause some of the existing lightpaths to become infeasible due to non-linear impairments. Therefore, it is important to ensure the feasibility of the existing lightpaths as well.

The OSNR tool takes 2 inputs, namely:

1. The routes of existing lightpaths and the new lightpath
2. The channels assigned to the existing lightpaths and the new lightpath

If any of the existing lightpaths or the new lightpath is translucent, then it is divided into the corresponding transparent segments before passing to the OSNR tool. Fig. 4.5 shows a sample network topology with 6 nodes and Table 4.6 shows the routes and wavelengths assigned to the existing lightpaths in this network. A new

Table 4.7: Route matrix: Input to OSNR tool

3	4	0	-1	-1	-1
3	1	-1	-1	-1	-1
1	2	5	-1	-1	-1
1	0	-1	-1	-1	-1
4	0	-1	-1	-1	-1
0	5	-1	-1	-1	-1

Table 4.8: Wavelengths assigned for the route matrix in Table 4.7

1	0	1	1	0	0
---	---	---	---	---	---

connection request from node 3 to node 5 is considered in Fig. 4.5 and BFS-RWA has explored the route $3 \rightarrow 4 \rightarrow 0$ so far. Tables 4.7 and 4.8 show the route and wavelength matrices to be passed to the OSNR tool. The tables are padded with -1 to make up the row length (which is the total no. of nodes in the network). The first row in Table 4.7 is the route of the new lightpath ($3 \rightarrow 4 \rightarrow 0$) and the remaining 5 rows represent the segments of existing lightpaths $L1$, $L2$ and $L3$ respectively. Similarly the first element in Table 4.8 is the wavelength assigned to the new lightpath and the remaining are the wavelengths assigned to the transparent segments of $L1$, $L2$ and $L3$ respectively. It can be observed for example that the existing lightpath, $L1$, is a translucent lightpath. Hence it is divided into transparent segments, namely $3 \rightarrow 1$ and $1 \rightarrow 2 \rightarrow 5$ (2nd and 3rd rows in table 4.7), before passing to the OSNR tool.

The OSNR tool measures the optical signal degradation for each of the lightpaths, represented by the route and wavelength matrices. It returns true only if all the lightpaths (existing and new) are feasible, otherwise returns false. It also returns the OSNR value of the last node in the new lightpath (used to calculate the actual cost in BFS-RWA). It is to be noted that the OSNR tool just gives the feasibility of the set of lightpaths that are passed to it and it does not make any decision with respect to the actual IA-RWA. Based on the lightpath feasibility information returned by the OSNR tool, the BFS-RWA module takes an appropriate decision to continue further with the exploration for an IA-RWA solution.

4.7 RRP Module

The network operation is performed in the RRP module, where the dynamic connection requests are established and taken down. The following input files are given to the RRP module from the simulator database:

- A real or synthetic network topology.
- The shortest distance matrix.
- A set of regeneration capable nodes.
- The connection setup/teardown event sequence.

The important functions of the RRP module are as follows:

- Look for new connection setup/teardown events.
- Add newly established lightpath to the set of existing lightpaths.
- Remove the corresponding lightpath on a teardown event.
- Update the list of resources (channels available and regenerators used) after every setup/teardown event.
- Record the RWA solution of the established lightpath.
- Record all blocked connection requests.

The RRP module starts by scanning an event from the input sequence. If the event is a connection setup, the RRP module passes on the request to the BFS-RWA. Otherwise if the event type is teardown, the resources allocated to the corresponding lightpath (including the wavelengths and regenerators used, if any) are recovered. These recovered resources are made available to future connection setup events.

The BFS-RWA is the core component of the RRP module that performs IA-RWA for the connection request. This component is the implementation of the proposed

BFS-RWA approach presented in Chapter 3. If the connection setup event is successful, the RRP module records the RWA solution of the newly established lightpath. Otherwise the connection request is recorded as blocked. Finally the simulation result is written back to the database.

5 RESULTS

The simulator presented in Chapter 4, was used to study the performance of the proposed BFS-RWA approach. In optical networks using dynamic lightpath allocation (DLA), the network performance is measured in terms of a metric called *lightpath blocking probability* [4], defined as the ratio of the number of lightpath requests that could not be satisfied (or blocked) to the total number of lightpath requests. The lower the lightpath blocking probability, the better is the performance.

This section presents the results of the simulations used to test the BFS-RWA approach. BFS-RWA has been tested using both real and synthetic network topologies. The real network topologies used in the simulations include NSFNET (14 nodes) [27], ARPANET (21 nodes) [27] and USANET (24 nodes) [28]. Synthetic networks of varying sizes namely 15, 30 and 60 nodes, were used in the simulations and 5 different topologies were generated for each size considered. Traffic load values of between 10 (low) to 50 (high) Erlangs were used in the simulations. For each of these traffic load values, 5 different sequences of connection requests were generated. As a result, for synthetic networks each blocking probability reported in this section is therefore the average of 25 simulation runs. For real network topologies, the reported blocking probabilities are the average of 5 simulation runs. A link between two nodes in the network is assumed to be composed of 2 separate uni-directional optical fibers, where each fiber supports either 16 or 32 channels as the case may be. Unless stated explicitly, the regeneration capable nodes in the network are assumed to be equipped with a sufficiently large number of 3R regenerators. An optical reach value of 300km (calculated using the OSNR tool parameters, considering only class 1 impairments) was used in the simulations.

In addition to studying the performance of the BFS-RWA approach, various aspects of translucent optical networks have been studied and presented in the subsequent sections.

5.1 Blocking Probability vs Traffic Load

Figs. 5.1 and 5.2 show how the blocking probability changes when the traffic load is varied, for 16 and 32 channels per fiber respectively. The blocking probability in general increases with the traffic load.

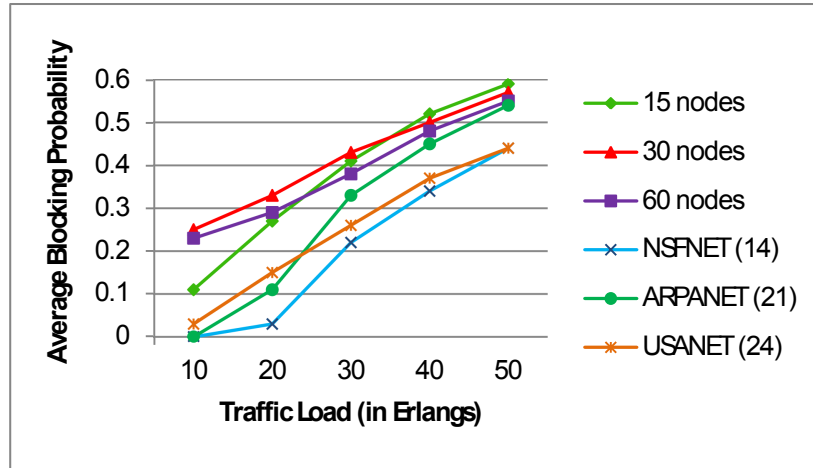

Fig. 5.1: Average Blocking Probability vs Traffic Load for 16 channels

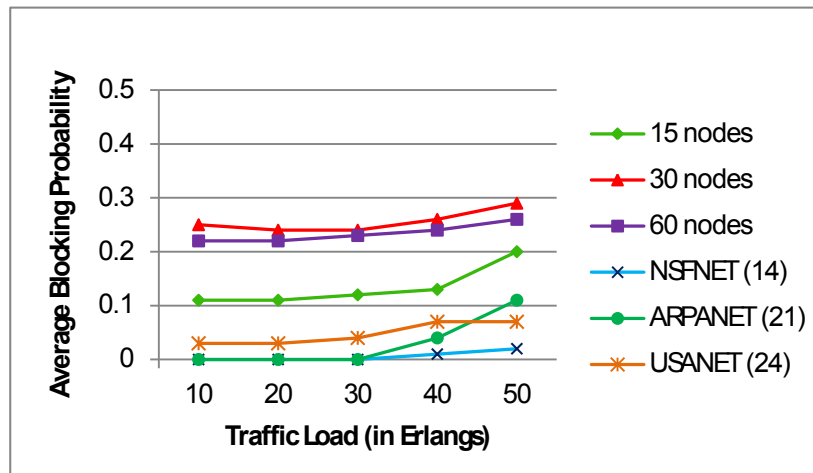

Fig. 5.2: Average Blocking Probability vs Traffic Load for 32 channels

It can be observed from Figs. 5.1 and 5.2, that the blocking probability is lower in the case of 32 channels compared to that of 16 channels for all the network topologies considered. This is an expected behaviour for any IA-RWA approach.

5.2 RPP using Different Values of Optical Reach

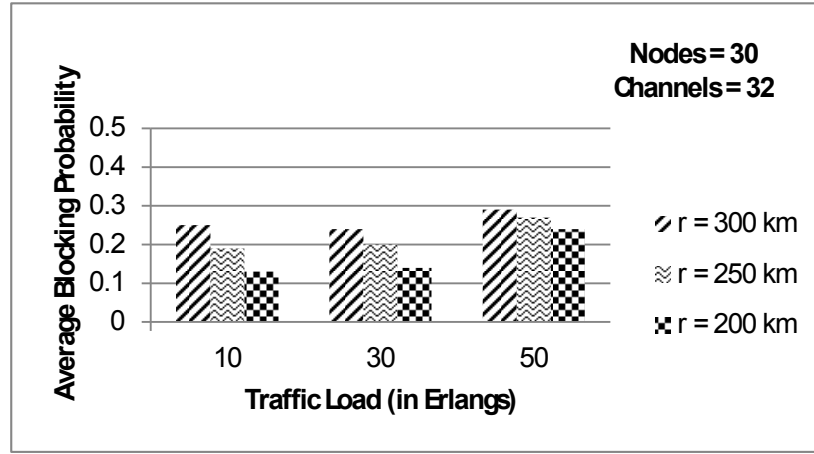

Fig. 5.3: Regenerator Placement using different values of optical reach (r)

Since the notion of optical reach considers only linear impairments, a regenerator placement strategy merely based on optical reach does not take into account the non-linear impairments. When designing WDM networks, it is important to have a firm basis for placing regenerators that takes into account the trade-off between the costs of regenerators and the blocking probability. The test bench, described in section 4, is ideally suited to study the extent to which non-linear impairments may be accommodated by reducing the optical reach below the level estimated using linear impairments. The OSNR tool used in the simulator gave 300 km as the value of the optical reach. If the optical reach is reduced to 250 km and 200 km, while identifying the regeneration capable nodes (RPP phase), we anticipate the blocking probability to be reduced.

Fig. 5.3 shows the impact of using a reduced optical reach, during the RPP phase, on the lightpath blocking probability. For traffic loads of 10, 30 and 50 Erlangs, the blocking decreased by 48%, 42% and 17% respectively for an optical reach of 200 km, compared to the actual optical reach of 300 km (which was based on linear impairments only). The immediate effect of reducing the optical reach is an increase

in the number of regeneration capable nodes. For instance, in the case of the 30 node network shown in Fig. 5.3, the number of regeneration capable nodes increased from 3 to 7 by changing the optical reach from 300 km to 200 km. This study shows the trade-off between the blocking probability and the number of regeneration capable nodes.

When a lightpath undergoes 3R regeneration, wavelength conversion is available implicitly at the regeneration capable nodes. It is well known that wavelength conversion has an effect on the blocking probability, since the wavelength continuity constraint [4] is relaxed at the node where 3R regeneration takes place. As indicated above, a lower optical reach leads to a greater number of regeneration capable nodes and hence a higher possibility of wavelength conversion. This is one of the important reasons for the reduction in the lightpath blocking probability. In this series of experiments each node, capable of 3R regeneration, was assumed to have a sufficiently large number of regenerators to be available.

5.3 Effect of Varying the Number of Regenerators

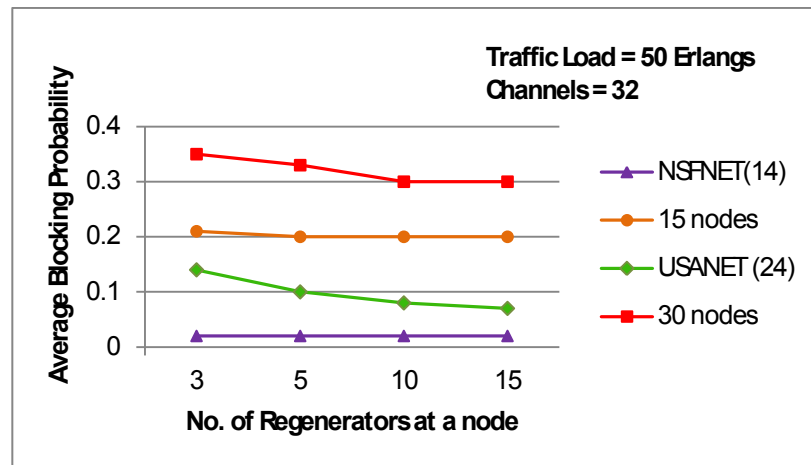

Fig. 5.4: Effect of varying the number of regenerators for 50 Erlangs

It is not reasonable to place a very large number of regenerators at a node, if the likelihood of using them is very small. If this number is too small, some additional lightpath connection requests will be blocked, due to the lack of free regenerators. Fig. 5.4 shows the impact of varying the number of regenerators at each regeneration site, on the blocking probability, for a high traffic load of 50 Erlangs. As expected, the blocking probability decreases, as the number of regenerators at the regeneration sites increases. This effect can be seen clearly in medium sized networks having 24-30 nodes. In small translucent networks, the number of regeneration capable nodes is very small (usually 1 or 2) and the number of lightpaths requiring regeneration is also relatively low. As a result, the reduction in blocking probability with increasing number of regenerators is negligible. The NSFNET and 15 node topologies shown in Fig. 5.4, are examples of small translucent networks. For NSFNET the average blocking probability is constant for all cases and for the 15 node topology the reduction is marginal from 3 to 5 regenerators.

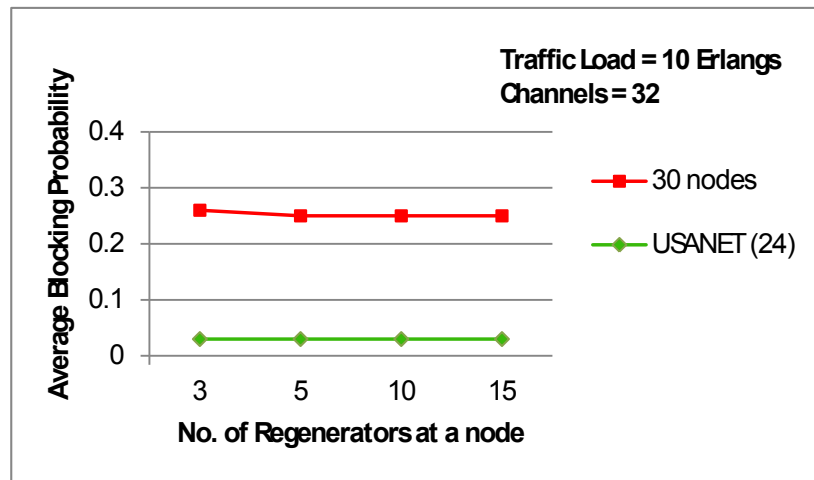

Fig. 5.5: Effect of varying the number of regenerators for 10 Erlangs

Fig. 5.5 shows the impact of varying the number of regenerators for a low traffic load of 10 Erlangs. In this case, the reduction in the blocking probability with increasing number of regenerators at a site, is extremely small. A lower traffic load

means lesser number of lightpaths in existence at any given point of time. Hence greater is the number of free channels available for new requests and also lesser is the impact due to non-linear impairments. As a result, only few lightpaths require regeneration and therefore the number of regenerators at a node becomes relatively less important.

5.4 Importance of RPP Approach

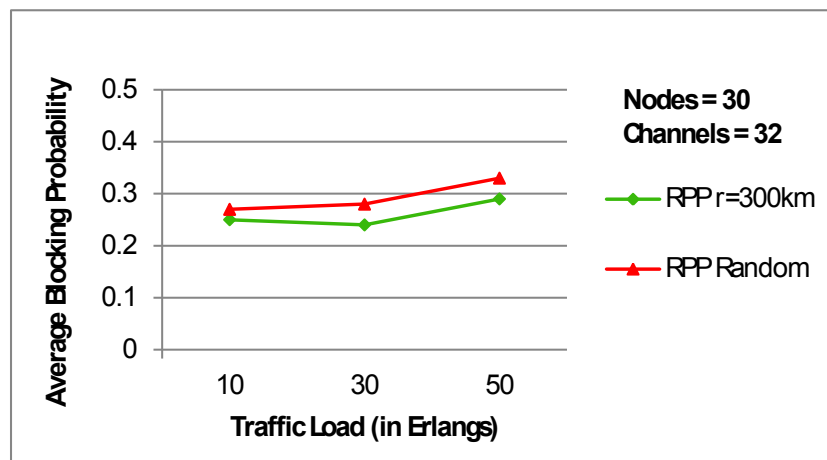

Fig. 5.6: RPP random vs RPP using optical reach = 300km

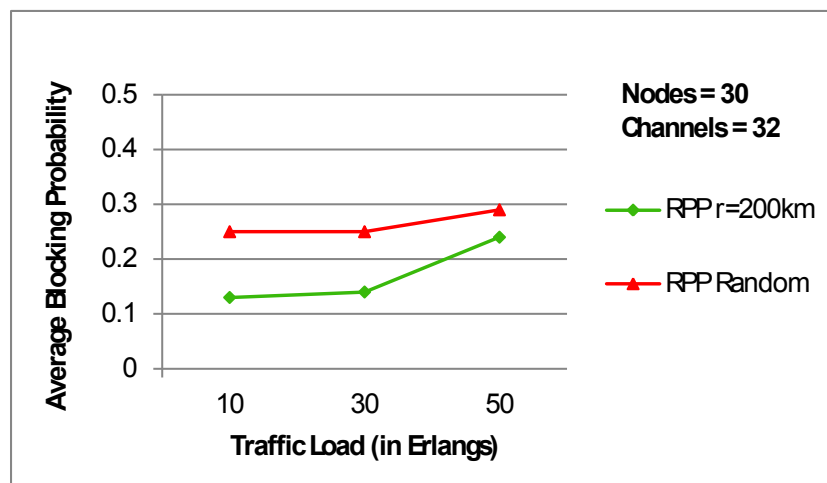

Fig. 5.7: RPP random vs RPP using optical reach = 200km

Figs. 5.6 and 5.7, compare the performance of 2 RPP strategies namely:

- (i) RPP approach based on optical reach (mentioned in section 4.7)
- (ii) An RPP approach which randomly identifies the regeneration capable nodes.

Two sets of separate simulations were performed, on a 30 node synthetic network topology, to measure the performance of the above mentioned RPP strategies. In the first set of simulations, the RPP approach (i) was used to identify the regeneration capable nodes using optical reach values of 300 km and 200 km. The RPP approach (i) identified 4 and 7 regeneration capable nodes for the network using 300 km and 200 km respectively. The BFS-RWA simulations were performed using the identified regeneration capable nodes. In the second set of simulations the RPP approach (ii) was used to randomly identify the same number of regeneration capable nodes as done by approach (i) (namely 4 and 7). The simulations were performed later using these regeneration capable nodes identified by approach (ii).

As shown in Figs. 5.6 and 5.7, the optical reach based RPP approach (i) offers a lesser lightpath blocking compared to the random approach (ii). It can be observed that, the difference in the blocking probabilities of the 2 RPP approaches is more when an optical reach of 200 km is used in approach (i). This is because with 200 km, the number of regeneration capable nodes is higher (i.e. 7). These experiments show that the RPP strategy used prior to the network operation, has a considerable impact on the lightpath blocking probability.

5.5 Effect of a Distributed Regenerator Placement

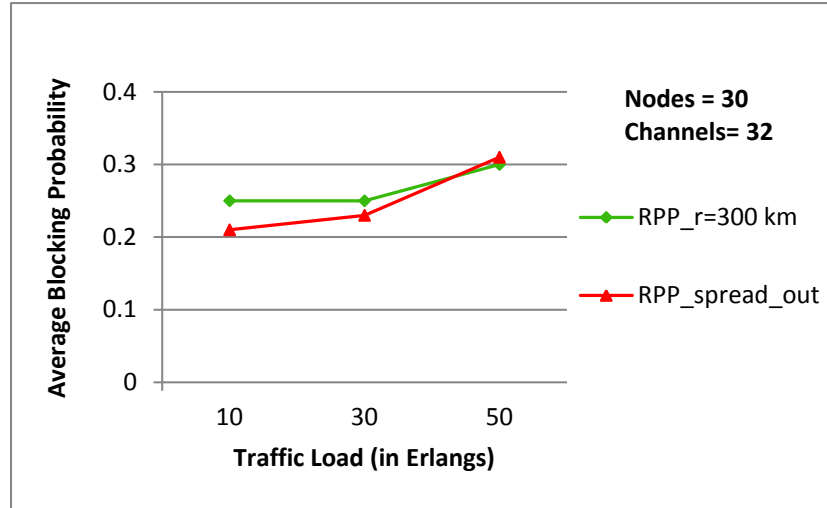

Fig. 5.8: Effect of distributing the available regenerators in the network

Fig. 5.8 shows a comparison of the blocking probabilities obtained by using two different regenerator placement strategies, with the same number of total regenerators. RPP_r=300km corresponds to the RPP approach which identifies the regeneration capable nodes using an optical reach of 300 km. 5 different network topologies with 30 nodes each, were considered. The RPP_r=300km approach identified 3 or 4 regeneration capable nodes for the topologies considered. 10 regenerators were deployed in each of the regeneration capable nodes. Hence, a total of 30 or 40 regenerators were used.

In the RPP_spread_out approach, the number of regeneration capable nodes was doubled (i.e 6 or 8 as the case may be) but the total number of regenerators was kept the same (30 or 40). As a result the number of regenerators at each of these nodes was reduced by half. Table 5.1 shows the number of regeneration capable nodes and the number of regenerators at each of these nodes, for both the RPP strategies considered in Fig. 5.8. The objective of distributing the available regenerators in the network, is to have a greater number of regeneration capable nodes, so that fewer

number of connection requests are blocked. As shown in Fig. 5.8, RPP_spread_out offers marginally lower blocking probability compared to the RPP_r=300km approach, for lower traffic loads of 10 and 30 Erlangs. For 50 Erlangs traffic, the blocking probabilities of both the RPP approaches, are approximately the same.

Table 5.1: Table showing distribution of regenerators

RPP Strategy	Number of Regeneration capable nodes	Regenerators per node	Total no. of regenerators
RPP_r=300km	3	10	30
RPP_spread_out	6	5	30
RPP_r=300km	4	10	40
RPP_spread_out	8	5	40

5.6 Opaque vs Translucent Optical Network

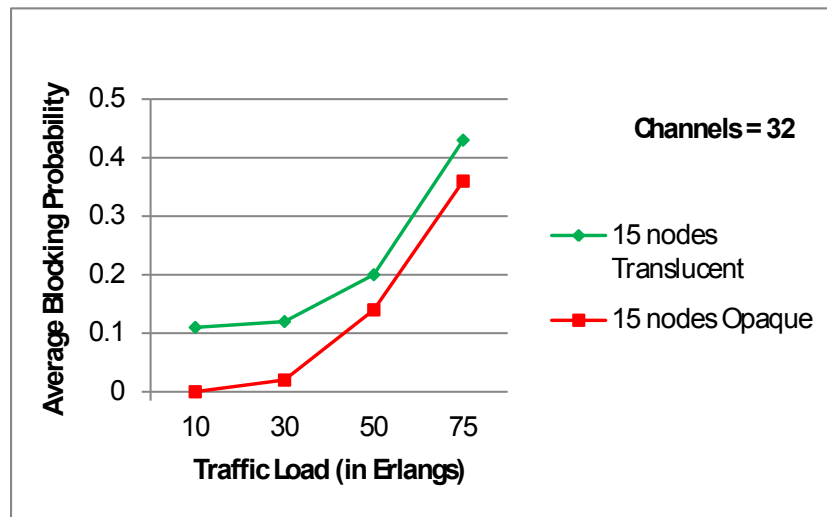

Fig. 5.9: Blocking probability: Opaque vs Translucent optical network

Fig. 5.9, shows a comparison of the blocking probabilities offered by 15 node opaque and translucent optical networks. In the opaque network, all the nodes are capable of providing regeneration. Whereas the translucent network has a sparse placement of

regenerators. As expected the opaque network performs better than the translucent network. But for higher traffic loads (50 - 75 Erlangs), the blocking probabilities of opaque and translucent networks are close to each other. It was observed that BFS-RWA takes a much longer time in the case of the opaque network compared to the translucent network. This is because of the fact that the number of potential solutions to explore, with all the nodes being regeneration capable, is very large.

5.7 Effect of Non-Linear Impairments

Fig. 5.10 shows the impact of non-linear impairments on the lightpath blocking probability. Two sets of experiments were conducted namely i) Using only linear impairments to estimate the optical signal degradation and disabling the non-linear impairments in the OSNR tool and ii) Using both linear and non-linear impairments to estimate the optical signal degradation.

The results in Fig. 5.10, clearly indicate a higher blocking probability in the case of both linear and non-linear impairments. This study shows the importance of considering non-linear impairments while estimating the optical signal degradation in an optical fiber.

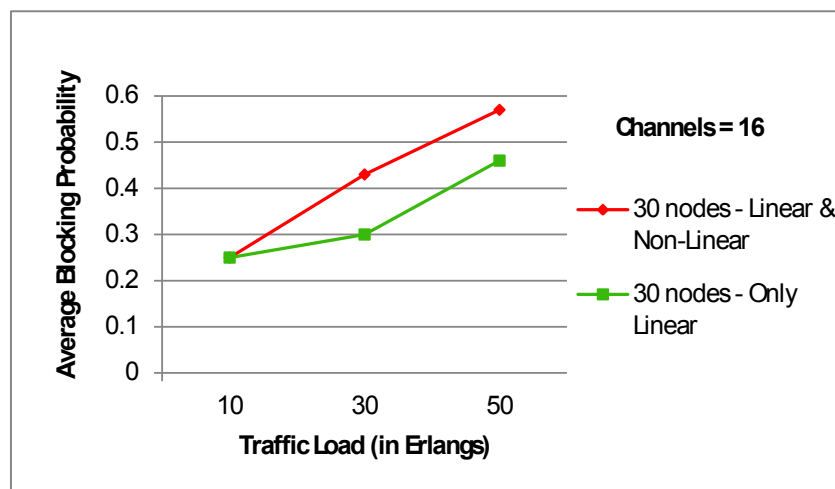

Fig. 5.10: Effect of non-linear impairments on blocking probability

5.8 Execution Time of BFS-RWA

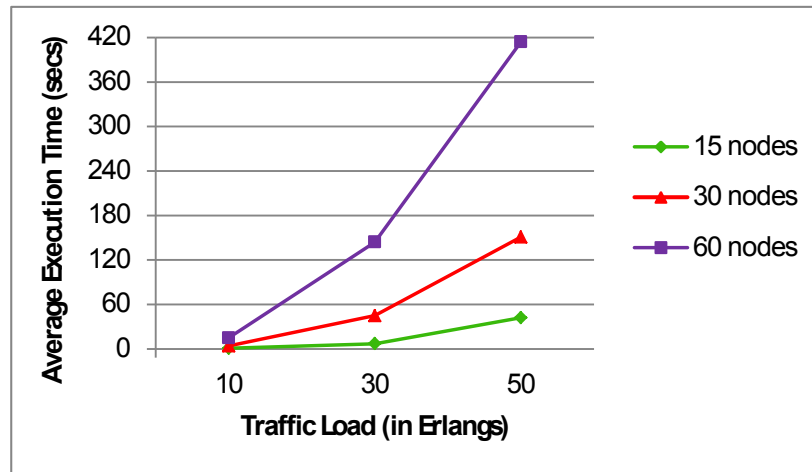

Fig. 5.11: Average execution time of 1 simulation(in secs)

Finally, Fig. 5.11 shows the average execution time of one complete simulation. One complete simulation means processing all requests for connections, for a given Erlang value, generated during an interval of one hour of network operation. The execution time was averaged over 25 simulations, using 5 randomly generated topologies. As expected, the execution times increase with traffic load and size of the network topology.

6 CONCLUSIONS & FUTURE WORK

6.1 Conclusions

This thesis presented a novel IA-RWA approach, called best first search RWA (BFS-RWA), for dynamic traffic demands in a translucent optical network. The BFS-RWA approach is based on the popular A* best first search algorithm and has been designed to guarantee an optimal solution (if it exists). In other words, BFS-RWA tries to find a lightpath, for every new connection request, that uses the least possible number of regenerators. In this respect, BFS-RWA provides a lower bound on the number of regenerators required to serve a connection request. None of the existing RRP approaches address the issue of optimal solution and therefore BFS-RWA is ideally suited to serve as a benchmark for future RRP heuristics.

This thesis also investigated the interesting possibility of occurrence of loops (i.e. sharing of one or more edges by segments) in a translucent lightpath. BFS-RWA uses graph theory techniques such as the intersection graph and list coloring, to ensure proper wavelength assignment, when a loop occurs in a translucent lightpath.

A simulation test bench, as described in Chapter 4, was developed to study various aspects of translucent optical networks, using BFS-RWA as the RRP approach. Extensive simulations were performed using the test bench, to study the performance of BFS-RWA. The test bench serves as a unique platform to study the cost vs performance trade-off of different regenerator placement strategies. It could also be used by optical network designers, to determine the number of regenerators to be deployed for various network topologies and traffic loads.

The test bench was used to study the importance of a regenerator placement strategy, in a translucent optical network. The simulation results⁸ indicate that the regenerator placement strategy used prior to the network operation, has a significant

⁸presented in sections 5.4 and 5.5

impact on the lightpath blocking probability.

Regenerator placement strategies in translucent optical networks generally use the optical reach based approach, to identify the regeneration capable nodes. As explained in Section 2.7.1, optical reach does not consider non-linear impairments and hence an accurate regenerator placement is not possible. In order to make the regenerator placement strategy more credible, the non-linear impairments were accommodated in the optical reach by overestimating the linear impairments. In other words, a lower optical reach reach was used to perform the simulations. The results⁹ indicate a positive performance improvement, in terms of the lightpath blocking probability, for lower optical reach values. However, it should be noted that a lower optical reach leads to a higher number of regenerators and hence higher cost. The test bench has been used to study this cost vs performance trade-off.

Simulations were conducted to specifically study the relative importance of non-linear impairments, while performing RWA. The results¹⁰ indicate that, non-linear impairments have a considerable impact on the lightpath blocking probability.

6.2 Future Work

An important consideration in any IA-RWA approach, is the tool used to estimate the physical layer impairments in the optical fiber. As the simulation results indicate, the non-linear impairments in particular have a significant impact on the lightpath blocking probability. Therefore, the accuracy of the result depends a lot on the credibility of the impairment estimation tool. In recent years, several impairment estimation models have been developed by researchers. The OSNR based analytical model [19], used in this thesis, is one of the many ways of estimating physical layer impairments. The *Q-factor* [17] based approach to estimate the QOT of an optical signal, is another popularly used technique to estimate impairments. A potential

⁹presented in Section 5.2

¹⁰presented in Section 5.7

future work would be, to study the performance of the proposed BFS-RWA approach, using the Q-factor tool [17]. It would be interesting to compare the behaviours of both the models namely, OSNR and Q-factor.

As an extension for the simulation test bench, graphical user interface (GUI) can be introduced to enhance the user experience. The user can be allowed to give inputs and configure all kinds of parameters through the GUI.

One of the other future works could be to devise meta heuristic and genetic algorithm based approaches for RRP. It would be interesting to compare the performance and execution times of BFS-RWA with these approaches.

REFERENCES

- [1] International Telecommunications Union: The world in 2013: Ict facts and figures
- [2] Prat, J.: Next-Generation FTTH Passive Optical Networks: Research Towards Unlimited Bandwidth Access. Springer (2008)
- [3] <https://fiber.google.com/about/>
- [4] Bandyopadhyay, S.: Dissemination of Information in Optical Networks: From Technology to Algorithms. Springer (2008)
- [5] Chlamtac, I., Ganz, A., Karmi, G.: Lightpath communications: an approach to high bandwidth optical wan's. IEEE Transactions on Communications **40**(7) (1992) 1171–1182
- [6] Azodolmolky, S., Klinkowski, M., Marin, E., Careglio, D., Pareta, J.S., Tomkos, I.: A survey on physical layer impairments aware routing and wavelength assignment algorithms in optical networks. Computer Networks **53**(7) (2009) 926–944
- [7] Ramaswami, R., Sivarajan, K., Sasaki, G.: Optical Networks: A Practical Perspective. 3rd edn. Morgan Kaufmann Publishers Inc., San Francisco, CA, USA (2009)
- [8] Christodoulopoulos, K., Manousakis, K., Varvarigos, E., Angelou, M.: Considering physical layer impairments in offline rwa. IEEE Network **23**(3) (2009) 26–33
- [9] Yang, X., Ramamurthy, B.: Sparse regeneration in translucent wavelength-routed optical networks: Architecture, network design and wavelength routing. Photonic Network Communications **10**(1) (2005) 39–53

- [10] Sen, A., Murthy, S., Bandyopadhyay, S.: On sparse placement of regenerator nodes in translucent optical network. In: IEEE Global Telecommunications Conference, IEEE GLOBECOM. (2008) 1–6
- [11] Saradhi, C., Zaks, S., Fedrizzi, R., Zanardi, A., Salvadori, E.: Practical and deployment issues to be considered in regenerator placement and operation of translucent optical networks. In: 12th International Conference on Transparent Optical Networks (ICTON). (2010) 1–4
- [12] Bandyopadhyay, S., Rahman, Q., Banerjee, S., Murthy, S., Sen, A.: Dynamic lightpath allocation in translucent wdm optical networks. In: IEEE International Conference on Communications, ICC '09. (2009) 1–6
- [13] Russell, S., Norvig, P.: Artificial Intelligence : A Modern Approach. Second edn. Prentice Hall (1995)
- [14] Yannuzzi, M., Quagliotti, M., Maier, G., Marin-Tordera, E., Masip-Bruin, X., Sanchez-Lopez, S., Sole-Pareta, J., Erangoli, W., Tamiri, G.: Performance of translucent optical networks under dynamic traffic and uncertain physical-layer information. In: International Conference on Optical Network Design and Modeling, ONDM. (2009) 1–6
- [15] Pachnicke, S., Luck, N., Krummrich, P.: Online physical-layer impairment-aware routing with quality of transmission constraints in translucent optical networks. In: 11th International Conference on Transparent Optical Networks, ICTON. (2009) 1–4
- [16] Tordera, E., Martinez, R., Munoz, R., Casellas, R., Sole-Pareta, J.: Improving ia-rwa algorithms in translucent networks by regenerator allocation. In: 11th International Conference on Transparent Optical Networks, ICTON. (2009) 1–4

- [17] Manousakis, K., Kokkinos, P., Christodoulopoulos, K., Varvarigos, E.: Joint online routing, wavelength assignment and regenerator allocation in translucent optical networks. *Journal of Lightwave Technology* **28**(8) (2010) 1152–1163
- [18] Zhao, J., Subramaniam, S., Brandt-Pearce, M.: Cross-layer rwa in translucent optical networks. In: *IEEE International Conference on Communications, ICC*. (2012) 3079–3083
- [19] Pereira, H., Chaves, D., Bastos-Filho, C., Martins-Filho, J.: Osnr model to consider physical layer impairments in transparent optical networks. *Journal of Photonic Network Communications* **18** (2009) 137–149
- [20] Ngo, S.H., Jiang, X., Horiguchi, S., Guo, M.: Dynamic routing and wavelength assignment in wdm networks with ant-based agents. In: *Embedded and Ubiquitous Computing*. Springer (2004) 829–838
- [21] Christodoulopoulos, K., Manousakis, K., Varvarigos, E.: Offline routing and wavelength assignment in transparent wdm networks. *IEEE/ACM Transactions on Networking* **18**(5) (2010) 1557–1570
- [22] Tommy R. Jensen, B.T.: *Graph Coloring Problems*. John Wiley & Sons (1995)
- [23] IBM: Ilog cplex: High-performance software for mathematical programming and optimization. <http://www-01.ibm.com/software/commerce/optimization/cplex-optimizer/>.
- [24] Levitin, A.: *Introduction to the Design and Analysis of Algorithms*. 3rd edn. Addison Wesley (2011)
- [25] Knuth, D.: *The Art of Computer Programming: Seminumerical Algorithms*. Volume 2. Addison-Wesley

- [26] Rahman, Q.: Optimization of WDM Optical Networks. PhD thesis, School of Computer Science, University of Windsor, Windsor, ON, Canada (2012)
- [27] Kim, S., Zhang, X., Lumetta, S.S.: Rapid and efficient protection for all-optical wdm mesh networks. *IEEE Journal on Selected Areas in Communications* **25**(9) (2007) 68–82
- [28] Ye, Y., Chai, T., Cheng, T.H., Lu, C.: Algorithms for wavelength division multiplexed translucent optical networks. In: Ninth International Conference on Communications Systems, ICCS. (2004) 361–365

VITA AUCTORIS

NAME: Sriharsha Venkata Varanasi
PLACE OF BIRTH: Hyderabad, India
YEAR OF BIRTH: 1987
EDUCATION: Visvesvaraya Technological University, Bangalore, India
Bachelor of Engineering, Computer Science 2006-2010
University of Windsor, Windsor ON, Canada
Master of Science, Computer Science 2011-2013